

Fox Tango International

Yaesu FT-201

Instruction manual.



For more information

[Visit the Yaesu FT-201 Web Page](#)

[Fox Tango FT-201 Web Page](#)

And If you have not already done so,

please visit our club Web Site at

[Fox Tango International Web Page](#)

Economical Mobile/Base Station FT-201



● Solid State 80 thru 10 Meter Transceiver

YAESU now brings you the newest addition to its growing family of Solid State transceivers; the FT-201. Performance and portability are among the key features of this economi-

cal transceiver along with YAESU innovated modules to simplify service and repair. The FT-201 has features which you would expect to find only in units costing much more.

Features

- * Built-in AC and DC power supplies
- * 260 Watts PEP SSB, 180 Watts CW & 80 Watts AM
- * Factory sealed, solid state VFO with 1 KHz readout
- * Effective Noise Blanker, threshold adjustable, for elimination of noise spikes
- * Built-in front panel adjustable VOX
- * Automatic break-in CW operation with sidetone
- * ± 5 KHz receiver clarifier
- * Built-in WWV/JJY reception
- * Adjustable carrier level for tune-up and Novice operation
- * Indicator lights for internal VFO and clarifier operation
- * All mode operation - SSB, CW, & AM
- * Fast or slow receiver AGC
- * Built-in internal crystal control provision and dual VFO adaptor
- * Built-in final cooling fan
- * Complete line of compatible accessories for flexible station design

Specifications

GENERAL

Frequency Range: 3.5–4.0 MHz, 7.0–7.5 MHz, 14.0–14.5 MHz, 21.0–21.5 MHz, 28.0–30.0 MHz, WWV 15 MHz (receive only).

Mode: Selectable USB, LSB, CW or AM.

Frequency Stability: Within 100 Hz during any 30 minute period after warm-up. Not more than 100Hz with 10% line voltage variation.

Calibration Accuracy: 2 KHz maximum after 100 KHz calibration.

Backlash: Not more than 50 Hz.

Antenna Impedance: 50 to 75 Ohm unbalanced nominal.

Circuitry: 32 Transistors, 9 FET, 6 Integrated Circuits, 52 Diodes and 3 Tubes.

Power Requirement: 100/110/117/200/220/234 V AC, 50/60 Hz, 380 Watts maximum, or 13.5V DC nominal, 6.7 A for standby, 0.7 A for

receive (Heater OFF) and 24 A for transmit.

Size: 340(W) x 153(H) x 285(D) m/m.

Weight: 15 Kg.

RECEIVER

Sensitivity: 0.3 μ V for 10 dB Noise plus Signal to Noise Ratio on 14 MHz.

Selectivity: 2.4 KHz nominal bandwidth at 6 dB down, 3.8 KHz at 60 dB down on SSB, CW and AM. 600 Hz nominal bandwidth at 6 dB down, 1.2 KHz at 60 dB down with optional CW filter. 600 Hz nominal bandwidth at 6 dB down, 12 KHz at 60 dB down with optional AM filter.

Harmonic & Other Spurious Response: Image Rejection better than 50 dB. Internal Spurious Signal below 1 μ V equivalent to antenna input.

Automatic Gain Control: AGC threshold nominal 6 μ V. Selectable AGC time constant, fast or slow. Fast attack time 3 milli-second and slow attack

time 5 milli-second. Fast release time 0.35 second and slow release time 2 seconds.

Audio Noise Level: Not less than 40 dB below 1 Watt.

Audio Output: 3 Watts to internal or external speaker at 4 Ohm impedance.

Audio Distortion: Less than 10% at 3 Watts output.

TRANSMITTER

Input Power: 260 Watts PEP on SSB, 180 Watts on CW at 50% duty cycle and 80 Watts on AM. (Slightly lower on 10 meter.)

Microphone: 50 K Ohm dynamic type.

Carrier Suppression: -40 dB.

Sideband Suppression: -50 dB.

Spurious Radiation: -40 dB.

Distortion Products: -30 dB.

Frequency Response: 300 Hz to 2700 Hz ± 3 dB.

Final Tube: 6JS6C x 2.

INSTRUCTION MANUAL

FT 201

Fox Tango International
<http://www.foxtango.org>

YAESU MUSEN CO., LTD.

TOKYO JAPAN

TABLE OF CONTENTS

	Page
GENERAL DESCRIPTION	1
SPECIFICATIONS	2
INSTALLATION	3
– General	
– Base Station Installation	
– Mobile Installation	
– Antenna	
INTERCONNECTIONS	4
CONTROLS AND SWITCHES	5
OPERATION	8
– Initial Check	
– Frequency Selection	
– Receiver Calibration	
– Transmitter Tune-Up	
– SSB Operation	
– CW Operation	
– AM Operation	
BLOCK DIAGRAM	11
CIRCUIT DESCRIPTION	12
– General	
– Receiver	
– Transmitter	
– Common Circuit	
– Power Supply	
ALIGNMENT	15
– General	
– Equipment Required	
– Alignment Procedure	
VOLTAGE CHART	22
RESISTANCE CHART	25
PARTS LIST	26

FT201

SSB TRANSCEIVER



GENERAL DESCRIPTION

The model FT-201 SSB Transceiver is a precision built, compact, high performance transceiver utilizing advanced design providing SSB (USB or LSB selectable), CW and AM modes of operation. The transceiver operates at an input of 260 watts SSB, 180 watts CW and 80 watts AM, on all bands from 80 to 10 meters.

All circuits, except the transmitter driver and linear amplifier, are transistorized. Plug-in modules are utilized, permitting easy maintenance.

The transceiver is self-contained, requiring only an antenna and an AC mains for home, portable or mobile operation. The transceiver may be operated from 100/110/117/200/220/234 volt AC sources when appropriately wired but is normally supplied for 117 volt AC and 12 volt DC operation. The two-way solid state power supply is an integral part of the unit. Two power cords are provided with the transceiver. Selection of AC or DC power source is automatically made when the proper line cord plug is inserted into the receptacle on the rear panel.

For mobile operation, a separate switch is provided on the front panel to turn off the tube heaters while in the receive mode. In this mode, the transceiver draws 0.5 amp less than your auto dash lights.

Features such as VOX/break-in CW with sidetone, 25 and 100 KHz calibrator, noise blanker, and 15 MHz WWV, are built-in. In addition, a dual VFO adaptor, crystal control adaptor, speaker and clarifier are integral parts of the unit. Provision is made for the installation of a 600 Hz crystal filter for the expert CW-DX operator. The CW filter is selected automatically when the transceiver mode switch is placed in the CW position.

The entire transceiver weighs approximately 14 kg and, is 340 m/m wide, 153 m/m high, and 285 m/m deep. Construction is of heavy gauge steel which provides an extremely rugged package, virtually immune to the effects of vibration and shock.

The SP-101PB/277PB, combination phone patch and external speaker, is a valuable optional accessory for base operation. The unit features an elliptical type speaker for high quality voice reproduction. Other optional equipment include the FV-201 external VFO and mobile mounting bracket.

SPECIFICATIONS

Frequency Range

3.5 – 29.7 MHz amateur bands (80 thru 10 m)
15 MHz (WWV) receive only

Type of Emission

USB or LSB (selectable)
CW, AM

Power Input

SSB 260 watts PEP
CW 180 watts 50% duty cycle
AM 80 watts
(slightly lower on 10 meter)

Carrier Suppression

50 db

Sideband Supression

50 db at 1000 Hz

Spurious Radiation

Down 40 db or better

Transmitter Frequency Response

300 Hz – 2700 Hz \pm 3 db

Distortion Products

Down 30 db or better

Antenna Output Impedance

50 – 75 ohm unbalanced

Frequency Stability

Less than 100 Hz drift in any 30 minute period

Sensitivity

0.3 μ V S/N 10 db

Selectivity

SSB, AM, CW 2.4 KHz at 6 db
4.0 KHz at 60 db
CW (with optional filter)
600 Hz at 6 db
1.2 KHz at 60 db

Audio Output

3 watts at 4 ohms

Power Consumption

AC Receive 45 watts
Transmit 350 watts max.
DC 12 V Standby 0.6 amp
Transmit 21 amp max.

Dimensions

340 m/m wide, 153 m/m high, 285 m/m deep

Weight

Approx. 14 kg.

INSTALLATION

GENERAL

The transceiver is designed to provide a complete, single unit installation, for fixed, portable, or mobile operation. Two prewired plugs are furnished with the unit for AC or DC voltage operation. This system provides the flexibility required for various installations and allows rapid change from fixed to mobile operation.

BASE STATION INSTALLATION

The transceiver is designed for use in many areas of the world using supply voltages that may differ from the operator's local supply voltage. Therefore, before connecting the AC cord to the power outlet, be sure that the voltage marked on the rear of the transceiver agrees with the local AC supply voltage. If not, refer to the power transformer connections on Page 14

CAUTION
PERMANENT DAMAGE WILL RESULT IF
IMPROPER AC SUPPLY VOLTAGE IS APPLIED TO
THE TRANSCEIVER.

The transceiver should be connected to a good ground. The ground lead should be connected to the terminal marked GND located on the rear panel of the transceiver.

MOBILE INSTALLATION

The transceiver will operate satisfactorily from any 12 volt negative ground battery source by connecting the DC power cord to the rear panel receptacle. For mobile installation, a special mobile mount is available from your dealer. A location should be selected clear of heater or air conditioning ducts. No special mounting precautions are necessary if adequate ventilation space is available. A minimum of two inches of air space above the cabinet top, and on all sides, is recommended to allow proper air flow around the cabinet. Never stack other units above or below the cabinet since the accumulated heat from both units could cause damage to the transceiver.

The transceiver requires an average of 14 amps on transmit and 24 amps on voice peaks. The fuse in the DC power cable should be rated 20 amps. When making connections to the car battery, be certain that the RED lead is connected to the positive (+) terminal and the BLACK lead to the negative (-) terminal of the battery. Reversed connections could damage the transceiver. The BLACK lead should run directly to the negative terminal of the battery. Using the car frame as a negative connection or connecting the positive lead at a point such as the ignition switch, places noise generating devices in the same current path as the transceiver and fails to take advantage of the filtering action of the battery. The power cable should be kept away from ignition wires, be as short as possible to minimize voltage drop and to provide a low impedance path from the transceiver to the battery.

Prior to operating the transceiver in a mobile installation, the voltage regulator setting should be checked. In many vehicles, the voltage regulation is very poor and in some cases the regulator may be adjusted for an excessively high charging voltage. As the battery and regulator age, the maximum voltage while charging can increase to a very high level which is not only detrimental to the battery but could cause damage to the transceiver.

The transceiver is designed to operate from a source voltage range of 11 to 14 volts. It is necessary to carefully set the regulator, so that the highest charging voltage does not exceed 14 volts. The transceiver should be switched "OFF" when vehicle is started to prevent voltage transient from damaging the power supply transistors.

ANTENNA

CAUTION
NEVER TRANSMIT WITHOUT HAVING PROPER
ANTENNA OR DUMMY LOAD CONNECTED TO
THE TRANSCEIVER.

The transceiver is designed for use with resonant antenna having a resistive load impedance of 50 - 75 ohms. The antenna is usually the most critical part of a station installation. Results, both in receiving and transmitting, will depend on how well the antenna is installed and adjusted. Any of the commercial antenna systems designed for use on the high frequency amateur bands may be used with the transceiver, provided the input impedance of the antenna system is within the capability of the transceiver pi-matching network (50 - 75 ohms). If a tuned open wire transmission line, or a long wire antenna is used, a suitable antenna tuner must be used between the antenna and the transceiver to provide an impedance match between the unbalanced coaxial output of the transceiver and the balanced open-wire feeder or long wire. For mobile operation, most of the commercially available antennas on the market will give good results when the coaxial cable is securely grounded to the chassis of the vehicle at the antenna mount. Adjust the antenna length carefully for minimum SWR after installation.

INTERCONNECTIONS

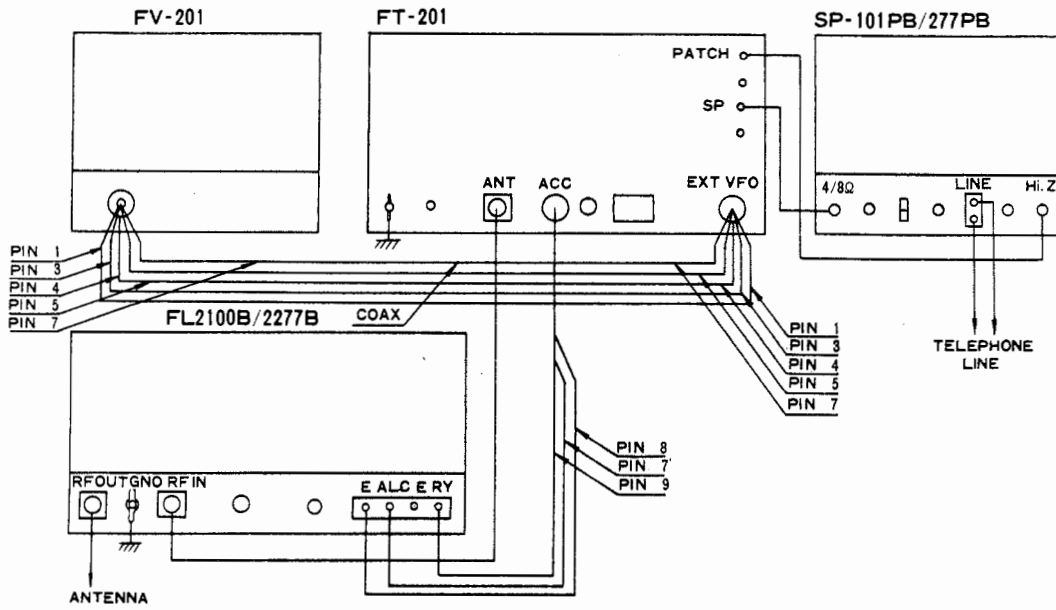

Fig. 1

FTV-650B/FTV-250 (6/2 METER TRANSVERTER)

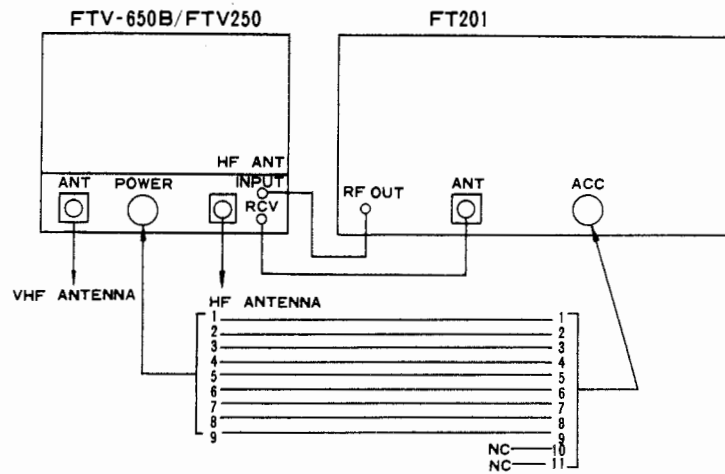

Fig. 2

CONTROLS AND SWITCHES

The transceiver has been specifically designed for ease of operation and versatility. All controls have been preset at the factory. Several of the controls are unusual in operation, and improper adjustment may result in signals of poor quality.

The various front panel controls and their functions are described in the following section. Be certain that you understand thoroughly the function of each control before operating the transceiver.

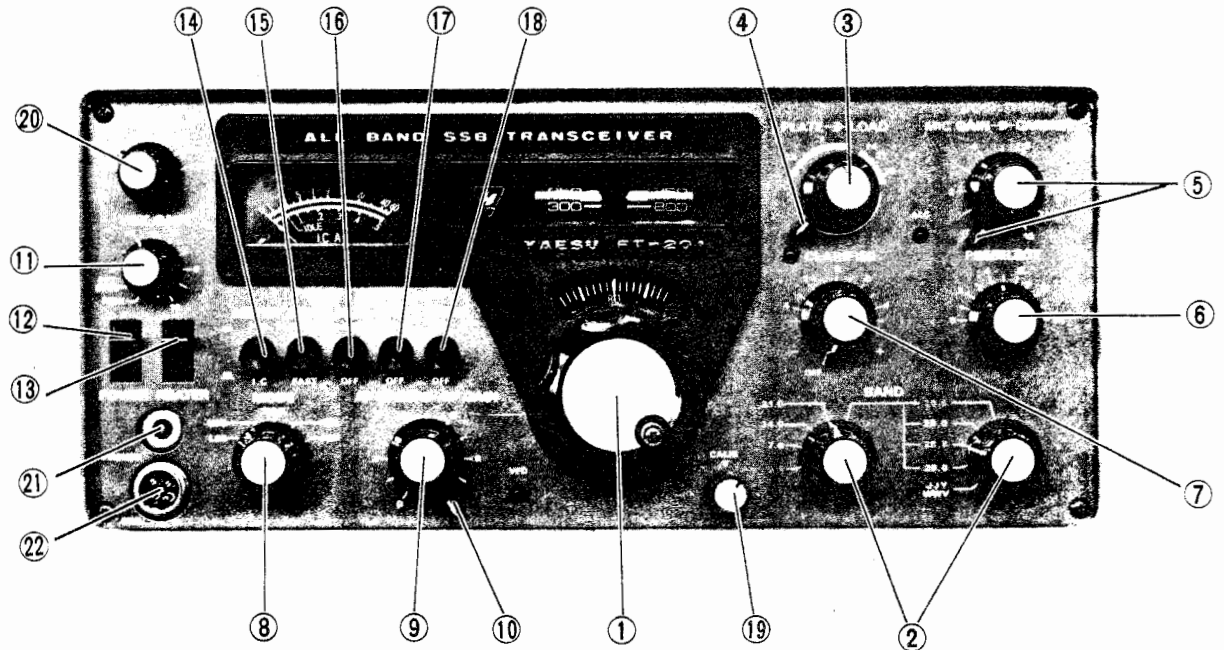

Fig. 3

(1) TUNING KNOB

The tuning knob located below the main dial window and in combination with the band switch, determines the actual frequency of operation. The VFO drive mechanism consists of a precision, spring loaded, split gear system in combination with a planetary drive unit to provide zero backlash at a low tuning rate. Each revolution of the tuning knob results in a frequency change of 16 KHz as indicated in the window above the knob.

(2) BAND SWITCH

The BAND switch is used to select the desired band for receiving and transmitting. The 10 meter band is divided into four bands which are selected separately when the MAIN BAND switch is set to the 10 meter band. For WWV reception, the MAIN BAND switch is set to 14.0 MHz band and the subswitch to the WWV position to receive WWV or JJY signals on 15 MHz.

(3) PLATE

Tunes plate circuit of the final amplifier.

(4) LOAD

Tunes the output circuit of the pi-network to match antenna and feed line impedance.

(5) MIC GAIN/CARRIER

The MIC GAIN and CARRIER controls are mounted on concentric shafts. The MIC GAIN control (inner

knob) varies the audio level from the microphone amplifier stage. The control has sufficient range to permit the use of any high impedance crystal or dynamic microphone.

The CARRIER control (lever control) varies the amount of the carrier in the CW, AM and TUNE modes of operation. For SSB operation, the CARRIER control should be set to fully counterclockwise position. The both MIC GAIN and CARRIER controls have maximum gain with the control set at 10 (fully clockwise position).

(6) PRESELECT

The PRESELECT control pretunes the signal circuits for both transmit and receive.

(7) CLARIFIER

The CLARIFIER control provides a means for tuning the receiver frequency ± 3 KHz of the transmitting frequency. Thus, it is possible to set the pitch of the voice you are receiving to the most readable point without affecting your transmitting frequency. Its use is particularly valuable in "net" operation when several participants may be transmitting slightly off frequency. The CLARIFIER control may be switched off and the receiver locked to the transmitting frequency by setting the CLARIFIER control to the OFF position. Normally, you will want to keep the CLARIFIER in the OFF position until the initial contact is made. The

CLARIFIER control may then be used to zero-in and correct any drift on the received signal. The red lamp lights up when the CLARIFIER is on.

(8) MODE SWITCH

The MODE switch is a five-position switch. This switch is used to select the mode of operation, LSB, USB, CW, AM or TUNE.

(9) AF GAIN

The AF GAIN control (inner knob) adjusts the audio output level at the speaker and phone jack. Clockwise rotation increases the audio output.

(10) RF GAIN

The RF GAIN control (lever control) varies the gain of the receiver RF and IF amplifier. Maximum sensitivity is obtained with the control set at 10 (fully clockwise).

(11) VOX GAIN

The VOX GAIN control is used to adjust the threshold level of VOX (Voice Control Operation). At fully counter-clockwise position (MOX), it locks transmitter "ON" and must be rotated to the PTT/STBY position for receiver recovery. At the PTT/STBY position, the transmitter is activated when the PTT switch on the microphone is pushed. For VOX operation, slowly advance the VOX GAIN control until the transceiver transmitter is activated by speaking normally into the microphone.

(12) POWER

The main switch turns transceiver "ON" for both AC and DC operation.

(13) HEATER

With this switch in the down position, the transmitter tube heaters are turned off. This reduces battery drain to 0.5 amp and thus permits long periods of listening without excessive battery drain. Pushing the switch to the upper position provides supply voltage to the tube heaters. After 30 second warm-up, the transmitter is ready for operation. This switch operates in both DC and AC modes.

(14) METER SWITCH

This switch selects the meter indication. When pressed down, it shows relative power output and at release position it shows the cathode current of the final tubes. In the receive mode, the meter works as S-meter regardless of the METER switch position.

(15) AGC SWITCH

This switch selects AGC time constant, either fast or slow.

(16) NB (Noise Blanker) SWITCH

In the down position, the noise blanker is placed in the circuit and eliminates noise pulses caused by auto ignition.

(17) ATT (Attenuator) SWITCH

This switch provides the insertion of a 20 db attenuator into the incoming signal path to minimize cross modulation which may be caused by extremely strong local signals.

(18) CALIB (Calibrator) SWITCH

The 100 KHz/25 KHz crystal oscillator is used to calibrate the receiver when this switch is pushed down. The 25 KHz generator switch is located under the top cover.

(19) CALIB CONTROL

This control adjusts the VFO frequency to calibrate against 100 KHz/25 KHz marker signal.

(20) VFO SELECT SWITCH

This switch provides selection of the companion external VFO or two fixed crystal oscillator positions. Normal operation of the transceiver VFO requires that the switch be placed in the "INT" position. When the internal VFO is on work, the red LED light turns on.

INT: The transceiver internal VFO controls both transmitter and receiver frequencies.

RX INT: The external VFO controls transmitter frequency and the internal VFO controls receiver frequency.

TX INT: The external VFO controls receiver frequency and the internal VFO controls transmitter frequency.

EXT: The external VFO controls both transmitter and receiver frequencies.

CH1 & CH2: Provides crystal control of the transceiver within the range of the bands installed in the unit.

Proper crystals may be installed on the PB-1386 crystal oscillator board for crystal controlled operation.

(21) PHONES

Headphone may be inserted in this jack for private listening. The internal speaker is disconnected when the headphone plug is inserted. Any high quality headphone may be used.

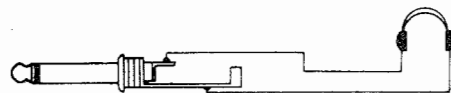

Fig. 4

(22) MIC

Microphone Jack. Four pin connector is used for microphone input, and push to talk relay actuation.

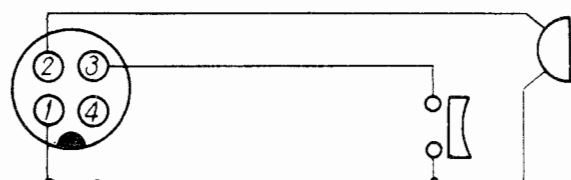

Fig. 5

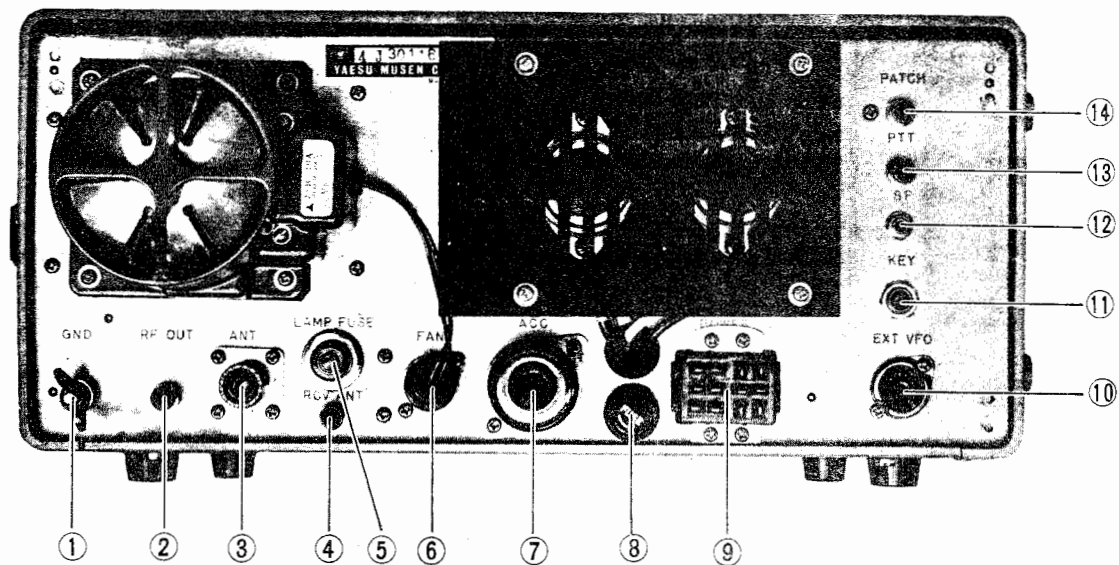

Fig. 6

(1) GND

Ground connection.

(2) RF OUT

The signal frequency output from the driver stage may be obtained at this jack for use of optional equipment.

(3) ANT

Coaxial connector for a 50 – 75 ohm antenna.

(4) RCV ANT

An auxiliary receiver antenna connection (such as our FR-101) may be made through this jack.

(5) LAMP FUSE

This lamp fuse protects the RF amplifier transistor receiver front end from damage which may be caused by an extremely strong local signal.

(6) FAN

Power outlet for cooling fan.

(7) ACC (Accessory Socket)

Accessory socket provides access to transceiver operating voltages and relay contacts. The plug should always be inserted when the transceiver is in use.

(8) FUSE

The fuse holder requires a 5 amp fuse for 117 volt or a 3 amp fuse for 220 volt operation. For DC operation, a 20 amp fuse is used in the fuse holder connected to the DC power cord.

(9) POWER

The power receptacle. Both AC and DC cords are supplied with the transceiver.

(10) EXT VFO

Connection for an external VFO.

(11) KEY

Key jack for CW operation.

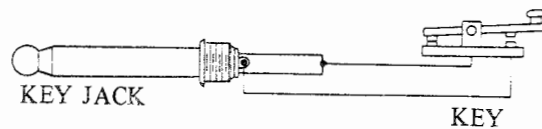

Fig. 7

(12) SP (Speaker)

Audio output is provided at this jack for an external speaker with an impedance of 4 ohms.

(13) PTT (Push-To-Talk)

This jack may be used for external actuation of the transmitter. As an example, a foot switch may be inserted into this jack to provide remote control of the transmitter PTT relay.

(14) PATCH

Speech input terminal for phone patch connection. Impedance is 50 K ohms.

OPERATION

The tuning procedure of the transceiver is not complicated, however care should be exercised when tuning to insure peak performance of the equipment. The following paragraphs describe the procedure for receiver and transmitter tuning.

INITIAL CHECK

Before connecting the transceiver to a power source, carefully examine the unit for any visible damage. Check that all modules and crystals are firmly in place and that controls and switches are operating normally. Be sure that the voltage specification marked on rear panel matches the supply voltage.

FREQUENCY SELECTION

The main tuning dial is color coded with the band selector switch for proper frequency read out. When the band selected is marked in white, the white numbers on the main tuning dial are read. When the band selected is marked in green, the green numbers on main tuning dial are read.

The main tuning dial is marked in 25 KHz increments between each 50 KHz segment. This provides a coarse frequency setting within the band. The dial skirt surrounding the tuning knob is marked in 1 KHz increments and provides for fine settings of the transceiver operating frequency.

Following the example shown (Figure 8), familiarize yourself with the relationship of the main and skirt dial frequency read out.

RECEIVER CALIBRATION

Preset the controls and switches as indicated below:

VFO Selector	INT (internal)
VOX GAIN	PTT
POWER	ON (upper position)
RF GAIN	Maximum (fully clockwise)
AF GAIN	As required
BAND	Desired band
MODE	Desired mode
TUNING	100 KHz point
PRESELECTOR	12 o'clock position
CLARIFIER	OFF
RF ATT	OFF
CALIBRATOR	ON

To calibrate, set the TUNING control to the 100 KHz point on the dial nearest the desired frequency. Tune the PRESELECTOR for maximum S-meter deflection. Tune the transceiver to the 100 KHz calibrator signal for zero beat.

Two signals may be heard near the 100 KHz point. One of these is a signal feeding through the IF stages. Always calibrate to the stronger of these two signals. To calibrate, set the skirt vernier dial to the zero

position. Rotate the CALIB knob near the tuning knob and zero beat against the 100 KHz marker signal. The transceiver must be calibrated when changing mode of operation: LSB, USB, AM or CW.

Move the calibrator switch under the top cover to the 25 KHz position and note that the calibrator signal can be heard at every 25 KHz point. The calibrator switch should be in the OFF position in normal use of the transceiver.

For bands 40-20-15-10A-10C, read the white scale on main dial. The setting shown in the example would then be 132.5 KHz plus the starting band edge frequency in MHz. For example, on 40 meters the frequency would be 7.1325 MHz. On 20 meters, 14.1325 MHz, etc.

For bands 80-10B-10D read green scale dial. Settings shown in the example would then read 632.5 KHz. For example, on 80 meters the frequency would be 3.6325 MHz, on 10B, 28.6325 MHz, etc.

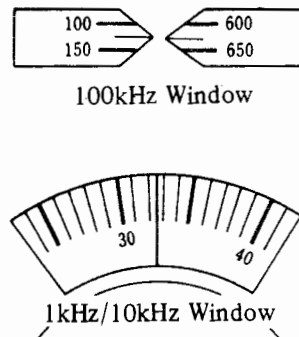

Fig. 8

TRANSMITTER TUNE-UP

The following tune-up procedure must be performed prior to selection of desired operating mode: LSB, USB, CW, or AM.

See the paragraphs relating to the specific mode after basic transmitter tune-up.

Connect a dummy load or matched antenna to the coaxial fitting on rear panel, and preset controls as follows:

POWER	OFF
HEATER	ON
MODE	TUNE
CARRIER	O (fully counter-clockwise)
BAND	Desired band
TUNING	Desired frequency
PRESELECTOR	12 o'clock position
PLATE	Desired band segment
LOADING	To position shown in Table 1
METER	IC
VFO SELECT	INT
VOX GAIN	PTT

LOADING POSITIONS

BAND	LOADING
80	5
40	5 1/2
20	3 1/2
15	3
10A	4
10B	4
10C	4
10D	4

Table 1

NOTE: These loading positions are nominal. Slight variations from the positions shown are to be expected.

With the transceiver turned on, allow 60 seconds for warm-up of the transmitter tubes.

Be certain that accessory plug is in the accessory socket since the heater voltage to the final tubes is supplied through a jumper between pins 1 and 2 of the accessory plug.

Set the VOX GAIN switch to MOX position. The meter will now read the final amplifier idling cathode current. This should be set at 60 mA with the BIAS control, VR1, located under the top cover. Return the VOX GAIN switch to the PTT position.

1. Pre-Tuning

- (1) Adjust the PRESELECT for maximum receiver noise level.
- (2) Place the VOX GAIN switch to the MOX position.
- (3) Rotate the CARRIER control until meter rises just above the normal idling current (60 mA)
- (4) Adjust the PRESELECT for a maximum meter reading. (Caution: if the meter reading exceeds 100 mA, reduce the CARRIER control).
- (5) Rotate the PLATE control for a minimum meter reading. (Plate Dip)
- (6) Return the VOX GAIN switch to the PTT position.

The transmitter is now pretuned to the desired frequency. Final peak tuning is accomplished by carefully following the final tuning procedure.

2. Final Tuning

Final peak tuning utilizes the meter in the relative power output position (P.O.). A full transmit power, the meter will read approximately one-half to two-thirds of full scale into a matched antenna load. If during final tune-up it is noted that the meter indication exceeds full scale, discontinue tune-up. Off scale meter indications are the result of reflected RF due to high VSWR and corrective action should be taken before attempting any further final tune-up.

CAUTION

EXCEEDING THE TIME LIMITS NOTED DURING FINAL TUNING MAY RESULT IN DESTRUCTION OF FINAL OUTPUT TUBES.

- (1) Set the METER switch to P.O. position, rotate CARRIER control fully clockwise to position 10.
- (2) Momentarily set the VOX GAIN switch to MOX (10 second maximum), and rotate the PRE-SELECT control for a maximum meter reading. Return the MOX switch to the PTT position.
- (3) Momentarily set the VOX GAIN switch to MOX (10 second maximum) and increase or decrease the LOADING control for a maximum meter reading. Return the MOX switch to the PTT position.
- (4) Momentarily set the VOX GAIN switch to MOX (10 second maximum) and increase or decrease the PLATE control for a maximum meter reading. Return the MOX switch to the PTT position.
- (5) Repeat steps (3) and (4) until a maximum meter reading is obtained.
- (6) Set the METER switch to the IC position. Rotate the PLATE tuning control slowly to assure that maximum power output occurs at a plate current dip.

The transmitter is now tuned for maximum output. Turn the CARRIER control fully counter-clockwise to the zero position. Return the METER switch to the IC position and the MODE switch to the desired operating mode.

NOTE: Moving the VOX GAIN switch to the MOX position in the above steps may be eliminated by simply operating the microphone PTT switch when a microphone is connected to the transceiver.

SSB OPERATION

After completion of the tuning procedure, set the MODE switch to LSB or USB. Set the VOX GAIN switch to the PTT position and advance the MIC GAIN control until the red light marked ALC starts to flicker when speaking normally into the microphone.

For VOX operation, advance the VOX GAIN potentiometer until your voice actuates the transceiver. Set the ANTITRIP potentiometer to the minimum point that prevents the speaker output from tripping the VOX. Do not use more VOX gain or ANTITRIP gain than necessary. Adjust the DELAY potentiometer under the top cover for a suitable release time.

NOTE: When the meter is set to IC, voice modulation peaks will indicate 150 – 200 mA. Actual peak current, however, is approximately 2 times the indicated value.

CAUTION

CARE MUST BE TAKEN TO AVOID EXCESSIVE DRIVE TO PREVENT SPURIOUS RADIATION. MAXIMUM KEY DOWN CURRENT SHOULD BE KEPT WITHIN 330 MA FOR THE BANDS UNDER 15 METER AND 280 MA FOR 10 METER BAND.

CW OPERATION

Upon completion of final tuning, set the MODE switch to the CW position and insert a key plug into the jack marked "KEY" on rear panel of the transceiver. The power output from the transmitter is determined by the CARRIER control position. The operator may select any power output desired by simply rotating the CARRIER control within the limits of its range from zero to ten.

The transceiver may be operated either manually or break-in by setting the VOX GAIN switch to either MOX (manual) or VOX (break-in) for the desired mode of operation.

The sidetone level may be adjusted with VR2 on AF unit under the top cover, for the desired level.

NOTE: Insertion of a key plug automatically disconnects the bias supply to the PA tubes. Therefore, with the key plug inserted, final amplifier bias current will not be indicated when meter is in the IC position.

AM OPERATION

AM operation of the transceiver is accomplished by setting the MODE switch to the AM position and inserting the proper amount of carrier with the CARRIER control.

After completion of the basic transmitter tune-up, place the MODE switch in the AM position and rotate the CARRIER control until the meter reads 150 mA in the IC position. While speaking into the microphone normally, increase the MIC GAIN until the meter indicates a very slight movement with voice peaks.

Care must be taken in adjusting MIC GAIN control to assure that the CARRIER control is not rotated causing an increase in carrier level. Do not exceed 150 mA meter indication during AM operation or damage to the final amplifier tubes may result.

CIRCUIT DESCRIPTION

GENERAL

The block diagram and the circuit description that follows will provide you with a better understanding of this transceiver. The transceiver utilizes plug-in modules to simplify trouble shooting and repair work. The transceiver is all solid state except for the final and driver stages.

The receiver and transmitter operate in a single conversion configuration utilizing a premix heterodyne technique which greatly reduces transmit and receive signal distortion.

RECEIVER

The incoming signal from antenna is fed through the antenna relay, lamp fuse and a 9 MHz trap coil to gate 1 of the RF amplifier Q5, 3SK40M, dual gate MOS-FET. The AGC (Automatic Gain Control) voltage is applied to gate 2 of Q2 to control the gain of this stage in order to avoid overloading in the following stages. The amplified signal from Q5 is then fed into gate 1 of the receiver mixer Q4, 3SK40M, where the incoming signal is mixed with the signal applied to gate 2 of Q4, from the premix circuit. This arrangement produces a 9 KHz IF signal at the output of Q4. The 9 MHz IF signal is fed through T101 and T102, to the first IF amplifier Q1, 2SC372Y, and amplified by Q1 and Q2, 2SC784R. The amplified signal passes through the crystal filter and is amplified by Q9, 2SC373, and Q10, 2SC373. The amplified signal is fed to the ring demodulator, D18 through D21, 1S1007, for CW and SSB reception. The carrier signal is also fed to the ring demodulator from the carrier oscillator unit for SSB and CW detection.

The output from Q10 is amplified by Q11, 2SK19GR, and applied to the AM detector D17, 1S1007. The detected audio signal is fed through mode switch and AF GAIN control to the first audio amplifier Q10, 2SC372Y. The amplified audio signal is further amplified by an audio power amplifier Q11, AN214, which delivers 3 watts audio signal to the speaker through pin 7.

A part of the signal passed through T101 and T102 is amplified by the noise amplifier Q3, 2SC372Y, and Q4, 2SC784R, in the IF unit.

The amplified noise signal is applied to the bias rectifier 1S1555. The rectified DC voltage is charged to C20 and acts as the bias voltage to D5, 1S1555. D5 conducts when the noise pulses exceed the bias voltage in the output from Q5. The output from D5 is amplified by pulse amplifier Q5 and Q6, 2SK19GR. The noise blanker driver Q7, 2SC372Y conducts to switch a noise blanker gate diode D1, 1S1555, which shunts the output of Q2 to ground whenever a noise spike exists. The switching level is adjusted with the noise blanker threshold control, VR1.

A part of the signal amplified by Q11, 2SK19GR, in IF unit, is rectified by AGC rectifier D14 and D15, 1S1555. The DC voltage is amplified by AGC amplifier, Q12 and Q13, 2SC372Y, and controls the gain of IF amplifier Q1, Q9, and RF amplifier Q5, automatically. The DC voltage at the emitter of Q13 is used for a meter deflection proportional to the input signal strength. The meter is calibrated in the customary "S" units. A meter indication of S-9 represents approximately 50 micro volts at the antenna terminal.

TRANSMITTER

The speech signal from the microphone is fed to the first speech amplifier Q1, 2SK19GR, from pin 10. The input impedance of the Mic amplifier is 50 Kilo ohms. The signal is controlled in amplitude by the MIC GAIN control and is fed to an integrated circuit Q2, LD3141, where the signal is amplified and delivered to the modulator through pin 1.

For SSB operation, the speech signal is fed to the ring modulator D1 through D4, 1S1007. The carrier signal of 9001.5 KHz for LSB or 8998.5 KHz for USB is also applied to the ring modulator to produce a 9 KHz DSB (double side band) IF signal. This IF signal is amplified by Q6, 2SK19Y, and is delivered to IF unit through pin 2. The signal is then amplified by IF amplifier Q14, 2SC372Y, and is fed through the crystal filter where the unwanted sideband is rejected. This signal is then applied to the second IF amplifier Q8, 2SC373, in IF unit. The amplified signal is fed to the transmitter mixer Q7, 2SC784R, where the signal is mixed with the heterodyne signal from premix circuit to produce the transmitting frequency signal.

For AM and CW, an 8999.3 KHz signal from the carrier oscillator is fed to the AM modulator Q5, 2SC372Y, and modulated by the speech signal fed through pin 8. Q5 operates as a buffer stage for CW operation. This AM or CW signal is amplified by Q8, 2SC373, and fed to the transmitter mixer Q7, 2SC784R. The transmitter mixer output signal is fed to the grid of transmitter driver V1, 12BY7A, where it is amplified to a level sufficient to drive the final linear amplifier V2 and V3, 6JS6C. Neutralization of the power amplifier is accomplished by feeding back a small amount of the output through TC1 to the cold end of the driver plate coil. The final output from V2 and V3 is fed through a pi-network to the antenna. With the METER switch in the IC position, the meter is connected to the cathode of final tubes through shunt resistor R29, and measures the total cathode current of the final tubes.

The ALC (automatic level control) voltage is obtained by rectifying a voltage across R23 with ALC diodes, D1 and D2, 1S1555, and controls the gain of the first transmitter IF amplifier, Q6, to prevent any distortion caused by over drive. The ALC voltage is amplified by Q7, 2SK19Y, and Q8, 2SC372Y, to illuminate the ALC LED on front panel in order to monitor the ALC action.

COMMON CIRCUIT

(1) Premix Circuit

The FT-201 transceiver utilizes a unique technique of premix to minimize the signal distortion. The VFO signal is premixed with a local crystal oscillator signal and is fed to the mixer stages of the transmitter and receiver. Crystal oscillator Q2, 2SC372Y, produces a heterodyne signal selected by the band switch. This signal is fed to the double balanced mixer Q1, MC1496G, where the signal is mixed with a signal from the VFO. The VFO module board is installed in the VFO chassis. The VFO oscillator Q1, 2SC372Y, produces a signal of 5 through 5.5 MHz. The oscillator output is fed to the pre-mixer Q1, MC1496G, through a buffer amplifier Q2, 2SC372Y. For 80 meter, the VFO signal is directly coupled to the transmitter and receiver mixer in the RF unit.

Varactor diode D1, 1S2236, in series with capacitor C15, is switched into the circuit by the CLARIFIER switch to shift the VFO frequency for receiver offset tuning. The pre-mixer output signal is fed to the transmitter and receiver mixer through a band pass filter and amplifier Q1, 2SK19GR, Q2, 2SC784R, and Q3, 2SC784R, in the RF unit.

PREMIX FREQUENCY CHART

BAND	XTAL	PREMIXER OUTPUT
80	—	5.6 — 5.5 MHz
40	21.5 MHz	16.0 — 16.5
20	28.5	23.0 — 23.5
JJY	29.5	24.0
15	35.5	30.0 — 30.5
10A	42.5	37.0 — 37.5
10B	43.0	37.5 — 38.0
10C	43.5	38.0 — 38.5
10D	44.0	38.5 — 39.0

Table 2

(2) FIX Oscillator

In addition to normal VFO operation, two crystals may be selected for crystal controlled operation with the selector switch located on the front panel of the transceiver. Crystal oscillator Q1, 2SK19GR, oscillates at the crystal frequency and its output is fed to the pre-mixer, MC1496G, through the VFO select switch. The crystal frequency may be shifted slightly by the CLARIFIER control. A red lamp lights up when the CLARIFIER control is in the "ON" position.

(3) Carrier Oscillator

The carrier oscillator functions at either 8998.5 KHz for USB or 9001.5 KHz for LSB, DEPENDING UPON WHETHER Q1, 2SC372Y, or Q2, 2SC372Y, is selected by the MODE switch. The output from the oscillator is fed to the buffer amplifier Q4, 2SC372Y, and then to the balanced ring modulator for transmit and also to the ring demodulator for receive. For AM or CW operation, an 8999.3 KHz crystal controlled oscillator Q3, 2SC372Y, operates to produce the carrier signal. In CW reception, Q1, oscillates at 8998.5 KHz signal for a beat signal. All oscillators are disabled for AM reception.

(4) Calibrator

The AF unit contains the 100 KHz/25 KHz marker generator. A crystal controlled oscillator Q1, 2SC735Y, oscillates at 100 KHz internally for dial calibration. A trimmer capacitor, TC1, is used to calibrate the 100 KHz against WWV or JJY on 15 MHz. The output from the oscillator is fed to a 25 KHz multivibrator Q3, MFC6020, which generates a marker signal every 25 KHz. The multivibrator operates when the 100 KHz/25 KHz switch is placed to 25 KHz position. The calibrator output is fed to the buffer amplifier Q2, 2SC735Y, to the receiver antenna circuit through pin 2 of PS-5.

(5) VOX Circuit

The signal from the first microphone amplifier is coupled through the VOX GAIN control potentiometer to the VOX amplifier, Q6, LD3141. The signal is amplified by Q6 and is fed to the VOX rectifier D5 and D6, 1S1555. The negative DC output voltage of the rectifier is applied to a DC amplifier Q8, 2SK19GR, causing the VOX relay controller Q9, 2SC373, to conduct and actuate the VOX relay.

The ANTITRIP circuit provides a threshold voltage to prevent the speaker output from activating the transceiver into the transmit mode. The receiver audio output from Q11 is connected through the ANTITRIP control, VR3, to the antitrip amplifier Q7, 2SC372Y, and fed to rectifiers D3 and D4, 1S1555. The DC voltage from the rectifiers, is connected to the gate of Q8, and thus reduces the gain of the VOX control amplifier and provides the necessary antitrip threshold.

The ANTITRIP control, VR3, adjusts the value of the antitrip voltage threshold so that the speaker output will not produce an excessive positive DC output from the VOX rectifier that exceeds the negative DC output from the ANTITRIP rectifier and thus causing the control transistor to actuate the VOX relay. When speaking normally into the microphone, the positive voltage will exceed the negative antitrip voltage and actuate the relay. VR5 provides a coarse adjustment for relay sensitivity. Relay hold time is determined by DELAY control, VR4.

(6) Sidetone Oscillator

The tone oscillator Q5, 2SC373 in the audio unit oscillates at approximately 800 Hz. The tone output is controlled by the keying circuit and coupled through the SIDETONE LEVEL control, VR2, to the receiver audio amplifier, Q11, for sidetone monitoring in CW operation. The output from Q5 is also coupled to the VOX amplifier, Q6, for break-in CW operation.

POWER SUPPLY

The power supply is designed to operate from either 100/110/117/200/220/234 volts AC or 12 volts DC (negative ground). Inserting the appropriate power plug into the rear panel receptacle makes the necessary connections to operate the supply in either the AC or DC modes. The power plug wiring is shown in Fig. 10

NOTE: THE PLUG NUMBERING MAY DIFFER DEPENDING ON THE MANUFACTURER. BE SURE USE AN EXACT YAESU CONNECTOR OR BE SURE TO OBSERVE ANY PLUG WIRING DIFFERENCES.

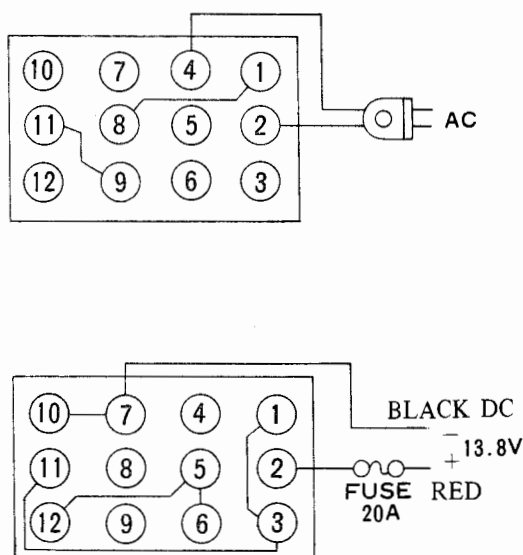

Fig. 10

When the transceiver is operated from a 12 volts DC power source, transistors Q1 and Q2, 2SB206, function as a low frequency (approximately 80 Hz) oscillator to provide AC to the power transformer. Starting bias for the oscillator is obtained from divider resistors R1, R2, and R3.

The power transformer has two primary windings which are connected in series or in parallel, for 100 through 234 volts operation. The primary windings are shown in Fig. 11 for various supply voltage.

For AC operation, 10.5 V AC voltage at power transformer secondary is rectified by D1 and D2, VO6B, for the transistor supply voltage. The 600 volts DC power amplifier plate voltage is supplied from the bridge connected rectifier, D5 through D12, 10D10. The 300 volts DC driver plate voltage is obtained from the center tap of the transformer winding in this circuit.

The 160 volts DC screen grid voltage is obtained from D3, 1S1943 and the -100 volts DC bias voltage is obtained from D4, 1S1943.

A highly regulated voltage is obtained from Q4, MFC6034A in AF unit, for use with the VFO.

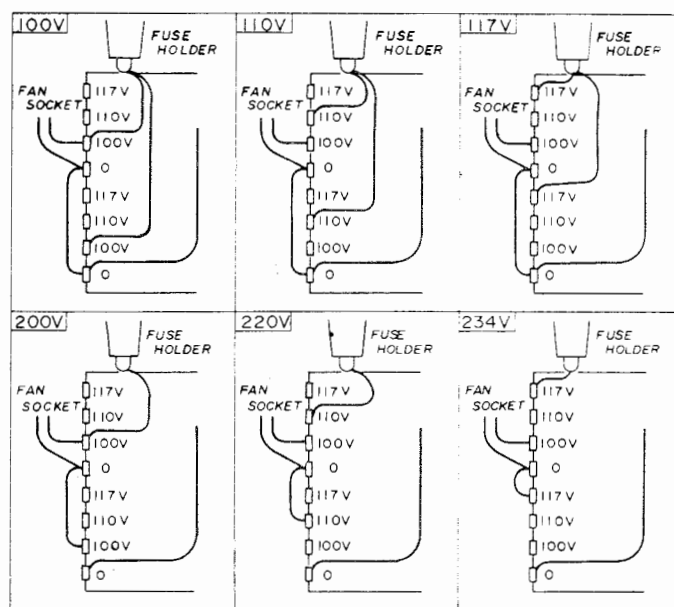

POWER TRANSFORMER CONNECTIONS

Fig. 11

ALIGNMENT

WARNING

DANGEROUS VOLTAGES ARE PRESENT. USE EXTREME CAUTION WHEN WORKING ON THE TRANSCEIVER WITH COVERS REMOVED. DISCHARGE ALL CAPACITORS BY SHORTING TO GROUND WITH AN INSULATED SCREW DRIVER.

CAUTION

NEVER OPERATE THE TRANSCEIVER IN THE TRANSMIT MODE WITHOUT A MATCHED ANTENNA OR ADEQUATE DUMMY LOAD. THE POWER AMPLIFIER TUBES AND PI-NETWORK COMPONENTS CAN BE DAMAGED IF THE TRANSCEIVER IS OPERATED WITHOUT THE PROPER LOAD TERMINATION.

GENERAL

The transceiver has been carefully aligned and tested at the factory and, with normal usage, should not require other than the usual attention given to electronic equipment. Service or replacement of a major component may require subsequent realignment, but under no circumstances should realignment be attempted unless the operation of the transceiver is fully understood, and the malfunction has been analyzed and definitely traced to misalignment.

Service work should only be performed by experienced personnel, using the proper test equipment.

EQUIPMENT REQUIRED

- (1) RF Signal Generator: Hewlett-Packard Model 606A, or equivalent with one volt output at an impedance of 50 ohms and a frequency coverage to 30 MHz.
- (2) Vacuum Tube Voltmeter (VTVM): Hewlett-Packard Model 410B, or equivalent VTVM with an RF probe good to 40 MHz.
- (3) Dummy Load: Waters Model 334A or equivalent 50 ohms nonreactive load rated at 300 watts average power.
- (4) AF Signal Generator: Hewlett-Packard Model 200AB, or equivalent.
- (5) A general coverage receiver covering the frequency range from 3 to 30 MHz with a 100 KHz calibrator.

NOTE: The following alignment procedures should be done in receive mode unless otherwise stated.

ALIGNMENT PROCEDURE

1. S-Meter Sensitivity

Place the transceiver in the receive mode and connect a signal generator to the antenna terminal of the transceiver. Set the signal generator to 14,200 KHz with an output of 50 μ V.

Tune the transceiver for a maximum S-meter reading. The S-meter should read S-9. If S-meter adjustment is required, adjust VR2 to obtain an S-9 reading.

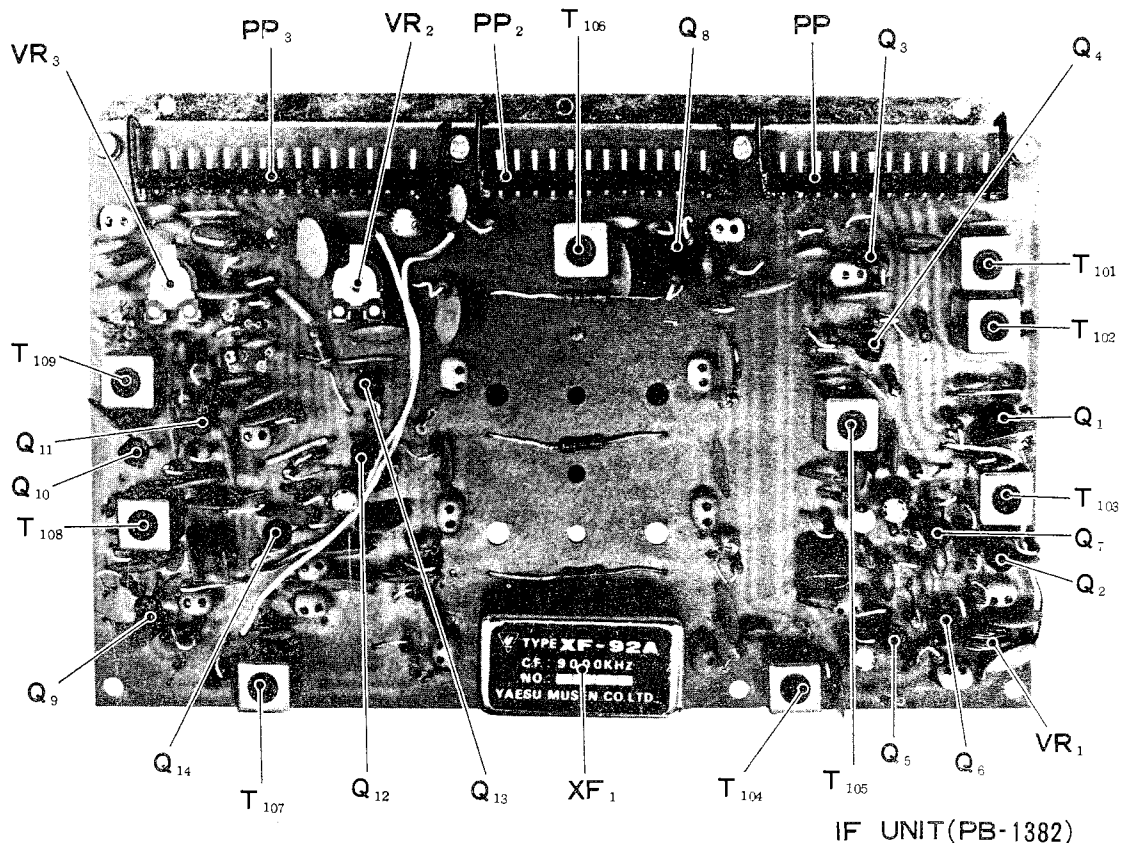

Fig. 12

When the transceiver is tuned to 14.200 KHz. the internal 100 KHz crystal calibrator output will be approximately 50 μ V or S-9 on the S-meter.

2. Noise Blanker Threshold

Tune the transceiver to a 100 KHz marker signal on the 3.5 MHz band.

Connect a VTVM between the test point illustrated in Fig. 13 and ground. Detune the main tuning dial approximately 5 KHz until the marker signal is not heard. Align T105 for a maximum VTVM reading, which should be approximately minus 0.07 volt.

The operating level of the noise blanker is determined by the THRESHOLD control, VR1. Counterclockwise rotation of the control increases the effectiveness of the blanker, however, extreme setting of this control reduces the receiver sensitivity. Tune the receiver to the 15 meter band and adjust the controls for maximum sensitivity. Adjust VR2 for minimum pulse noise. The noise blanker is not effective against continuous noise, however is quite effective on short, pulse type noises.

Extremely strong signals may cause distortion on the received signal due to mixing in the switching diode.

This effect can be reduced by decreasing the Noise Blanker Threshold control or by switching the Noise Blanker to "OFF".

3. VOX Adjustment

The VOX controls are located on PB-1385, AF unit. These are VR3 Antitrip, VR4 Delay, and VR5 Relay sensitivity.

VR1 VOX GAIN control is located on the front panel. Set the VOX GAIN switch to the PTT position and turn the AF GAIN and MIC GAIN controls fully counterclockwise. Slowly rotate the RELAY control (VR5) clockwise until the relay activates, then return the control slowly counterclockwise until relay releases. This release point is the proper setting for the RELAY sensitivity control.

Set the MIC GAIN control to the center of its travel. Speak into the microphone normally, and adjust the VOX GAIN control, VR1, to just activate the VOX relay.

Tune in a signal and adjust the AF GAIN control to a comfortable listening level. Set the ANTITRIP control VR3 to the minimum point that will prevent the speaker output from tripping the VOX relay.

Adjust the DELAY control, VR4, for suitable release time.

4. CW Sidetone Level

The CW sidetone level may be adjusted with the SIDETONE level potentiometer, VR2, located on PB-1385.

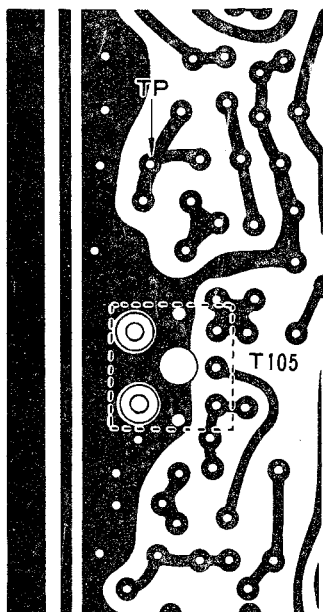

Fig. 13

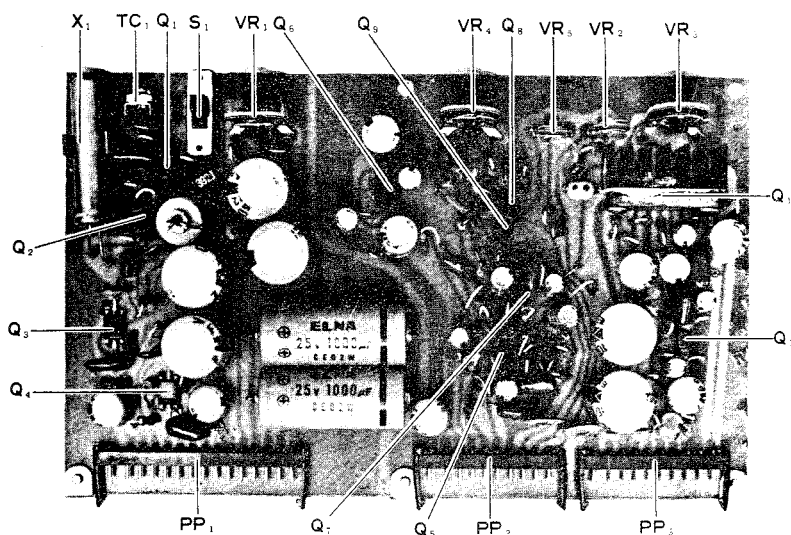

Fig. 14

5. Carrier Balance

The transceiver should be allowed to reach operating temperature before making the carrier balance adjustment.

Tune-up the transceiver for SSB operation using an antenna or dummy load. Turn the MIC GAIN control fully counterclockwise to remove all audio from the modulator stage.

With the MODE switch set to either the LSB or USB position, set the VOX GAIN control to the MOX position and adjust the carrier balance controls, VR1 and TC4, for minimum PO meter reading.

A more accurate balance may be obtained by tuning a receiver, having an S-meter, to the transmitted frequency. Adjust the balance controls for minimum S-Meter reading while switching the MODE switch back and forth between the two sideband modes to obtain good carrier suppression for both sidebands.

The carrier frequency is adjusted by TC1 for USB and TC2 for LSB in order to place the carrier frequency to approximately the 25 db down point on the filter response skirts.

Carrier balance for the receive ring demodulator can be adjusted with VR3. Disconnect the antenna from the transceiver, change the MODE switch from LSB to USB and adjust VR3 for a zero S-meter reading.

6. CW and AM Carrier Oscillator

Connect a frequency counter and an RF probe of a VTVM to pin 8 of PS-3 on IF unit PB1382.

Set the MODE switch to TUNE, the HEATER switch to OFF, the SELECT switch to TX EXT and the VOX GAIN to the MOX position. Advance the CARRIER control fully clockwise. Adjust TC3 for 8999.3 KHz on the counter and TC6 on carrier oscillator unit for a 0.5 volt VTVM reading.

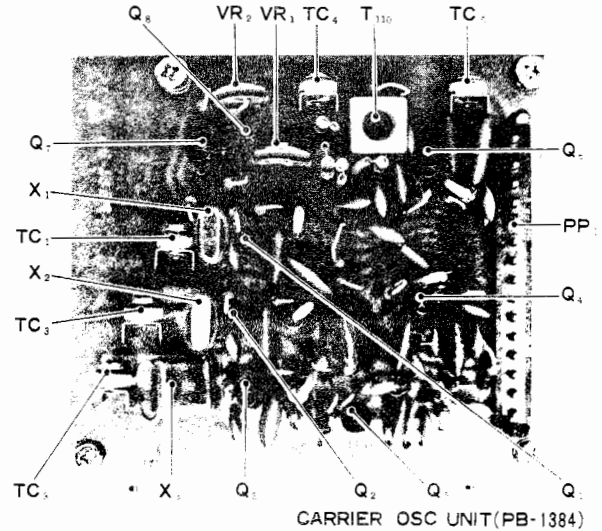

Fig. 15

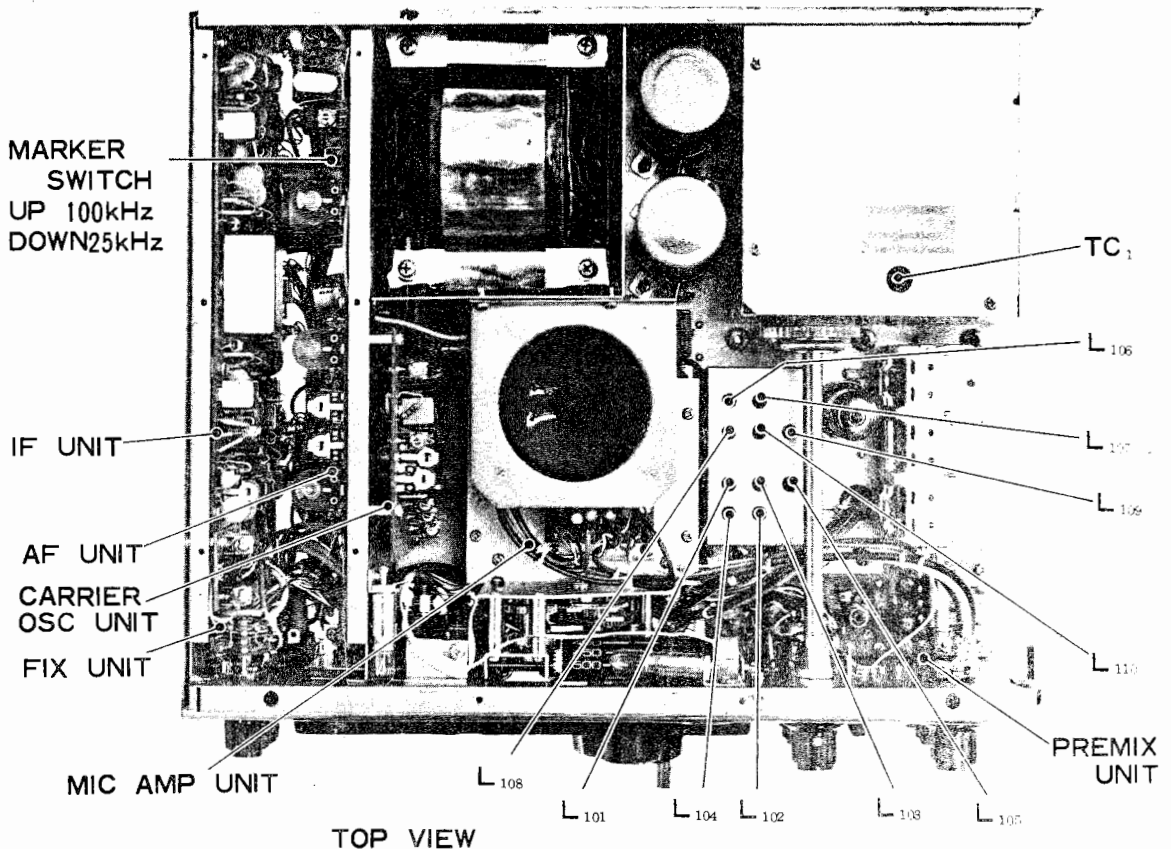

Fig. 16

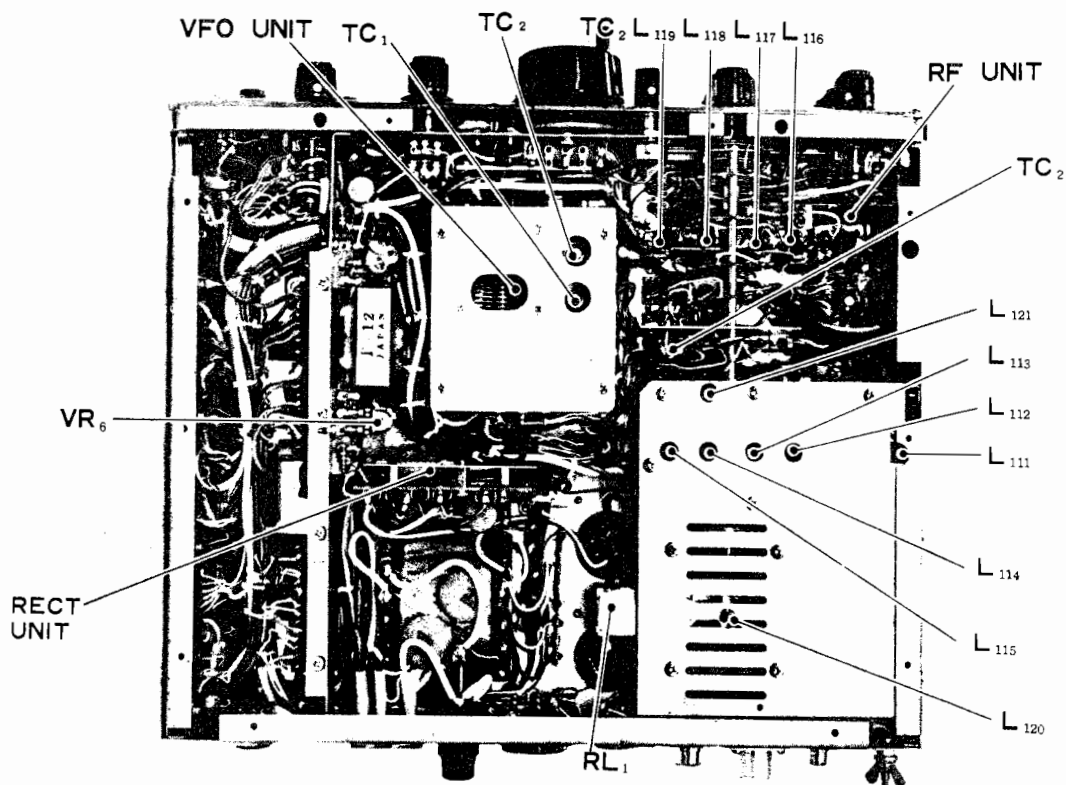

Fig. 17

BOTTOM VIEW

CAUTION

HIGH VOLTAGES ARE PRESENT ON UNDERSIDE OF CHASSIS AND ON THE INSIDE OF THE FINAL COMPARTMENT. USE EXTREME CARE WHILE MAKING ADJUSTMENTS WITH THE WIRING EXPOSED.

7. Clarifier

The frequencies coincide at CLARIFIER control OFF and O position in the receive mode. If not, adjust potentiometer VR6, located near the choke coil, under the main chassis.

8. Bias

The final amplifier bias must be checked to insure linearity and normal operating plate dissipation for the final tubes.

Adjust the BIAS control, VR1 on PB-1385, as follows: Set the transceiver to the receive mode and allow it to reach operating temperature (approximately 3 minutes). Set the MODE switch to USB, the METER switch to IC and the VOX GAIN control to the MOX position for the transmit mode.

The meter will indicate PA plate idle current.

The idle current is 60 mA, which is marked as "IDLE" on the meter scale.

If the idle current is other than this value, adjust the BIAS control for the correct value.

There is a little difference in the idle current between AC and DC operation. Adjust the idle current to 60 mA for each operation.

9. Final Amplifier Neutralization

When replacing the final amplifier tubes, it may be necessary to reset the bias to give a correct idle current. In addition, also check the neutralization. The procedure outlined below will guarantee maximum output and prolonged tube life.

- (1) Connect a dummy load to the antenna, and set the meter to IC.
- (2) Locate, TC1, the neutralization variable capacitor shaft on the chassis in the final amplifier section.
- (3) Check the final amplifier idle current in both the USB and LSB positions and adjust as previously described.
- (4) Tune-up the transceiver at 29 MHz, 10B or 10C band, with the MODE switch in the TUNE position, and advance the CARRIER control until the meter IC reads 100 mA.
- (5) Rotate the PLATE tuning control and observe the dip as indicated on the meter. If the dip is not prominent, reduce the loading control slightly for a better indication. As the PLATE control is rotated, the meter should rise equally and smoothly on either side of the maximum dip indication.
- (6) Determine which side of the dip rises abruptly. Set the PLATE control slightly to this side of dip, keeping the meter reading below 100 mA.
- (7) Using a nonmetallic tuning wand, rotate the neutralization capacitor shaft a small amount in the direction which reduces the current shown on the meter. Repeat steps (6) and (7) until the meter indicates a smooth and equal rise on either side of the maximum dip point.

The final compartment cover must be in place in order to maintain the RF shielding required during the neutralization procedure.

10. Marker Generator

Set the BAND switch to WWV/JJY position and tune the transceiver to the WWV/JJY signal. Zero beat the marker signal against WWV by adjusting TC1. It may be necessary to change the 50 pF ceramic capacitor connected in parallel with TC1, whenever the marker crystal is replaced.

11. Premix Circuit

- (1) Connect the RF probe of a VTVM to the T.P. terminal of the premix unit.
- (2) Set the BAND switch to 29.5 MHz. Set the trimmer capacitor, TC8, to its mid point. (half capacitance)
- (3) Peak L140 for a maximum VTVM reading, and then rotate the core clockwise until the VTVM reading indicates 90 mV.
- (4) Readjust TC8 until the VTVM reading indicates 40 mV.
- (5) Set the BAND switch to 29.5 MHz and adjust TC7 for 40 mV.
On 28.5 MHz, adjust TC6 and on 28.0 MHz, adjust TC5, for a 40 mV VTVM reading.
- (6) Set the BAND switch to 21 MHz and adjust TC4 for a 30 mV VTVM reading.
On 14 MHz, adjust TC2 for 25 mV, and on 7.0 MHz, adjust TC1 for 50 mV.
- (7) Set the BAND switch to 14 MHz and the subswitch to WWV/JJY and adjust TC3 for a 50 mV VTVM reading.

- (8) Disconnect the VTVM from the circuit.

Set the Standard Signal Generator to 14.245 MHz and its output voltage to 60db. Tune the transceiver to the SSG signal.

Then tune to the 14.255 MHz spurious signal and adjust VR1 for a minimum S-meter indication in order to balance pre-mixer Q1, MC1496G.

- (9) Connect the RF probe of the VTVM to TP terminal "RF" near Q7 of the RF unit. (Refer to Fig. 19)
- (10) Set the BAND switch to 7.0 MHz band, and the VFO dial to 250 KHz.

Temporarily solder a 470 ohm resistor between A, B and C terminals of L116. Peak the coil closest to the chassis. Two coils are sound on the coil form for a maximum VTVM reading.

Disconnect the one end (A terminal) of the temporary 470 ohm resistor and solder it to the B terminal.

Peak the coil on the other end of the coil form for a maximum VTVM reading. The VTVM reading should be approximately 0.4 volt.

Disconnect the temporary 470 ohm resistor.

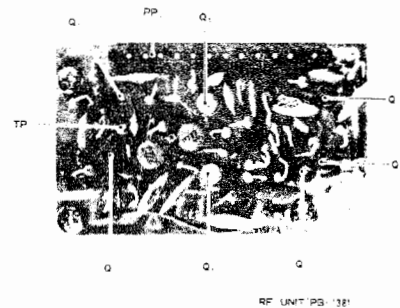

Fig. 19

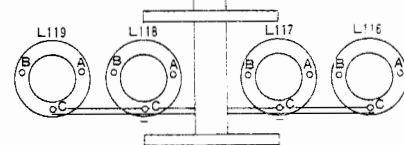

Fig. 20

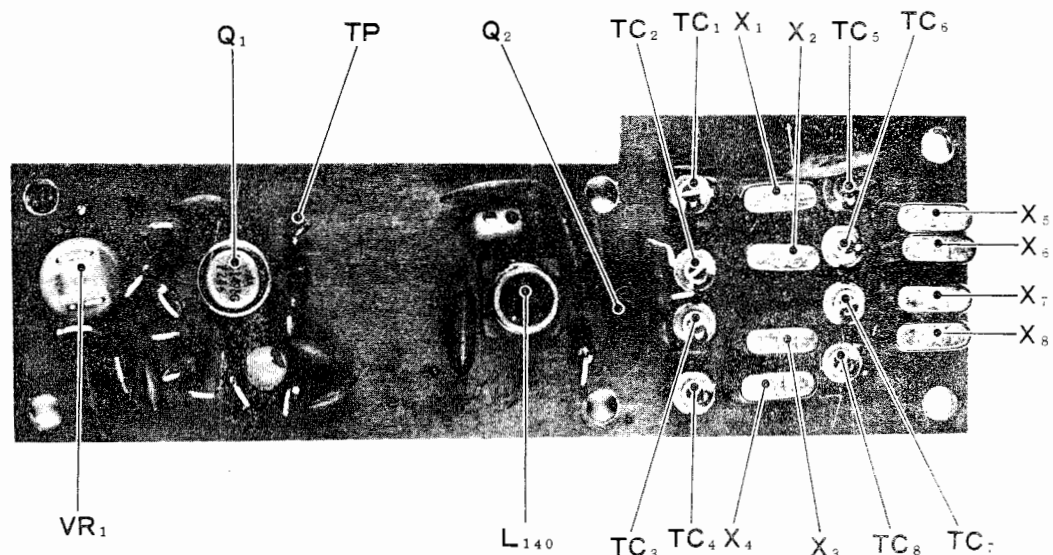

Fig. 18

PREMIX UNIT (PB-1383)

- (11) Set the BAND switch to 14.0 MHz, the sub band switch to 28.0 MHz and the VFO dial to the 500 KHz position.

Temporarily solder a 470 ohm resistor between terminal A and C of coil L117 and peak the coil closest to the chassis for a maximum VTVM reading. Disconnect the A terminal end of the 470 ohm resistor and solder it to the B terminal.

Peak the other coil for a maximum VTVM reading. (approximately 0.4 volt)

Remove the resistor from the terminals.

Set the VFO dial to 0 KHz. and check the VTVM reading.

It should be approximately 0.3 volt.

Set the sub band switch to the JJY WWV position and check for a 0.3 volt VTVM reading.

- (12) Set the BAND switch to the 21.0 MHz band and the VFO to the 250 KHz position. Repeat the same procedures as in step (9). for coil L118. The VTVM reading should be around 0.3 volt over the entire range of the VFO.

- (13) Set the BAND switch to 28 MHz, the sub band switch to 28.5 MHz and the VFO dial to 250 KHz.

Repeat the same procedures as step (9) for coil L119. The VTVM reading should be approximately 0.25 volts. Check the VTVM reading when the sub band switch is set to the other 28 MHz settings.

It should be 0.25 volts or more.

Be sure that L119 is tuned to 37–39 MHz. Extreme care should be observed in order that the coil is not tuned to the heterodyne crystal frequencies of 42.5–44.0 MHz. When the VFO switch is set to the EXT position, the VTVM reading should be zero.

If not, it may be mistuned to the heterodyne crystal frequency.

Disconnect the VTVM from the test point.

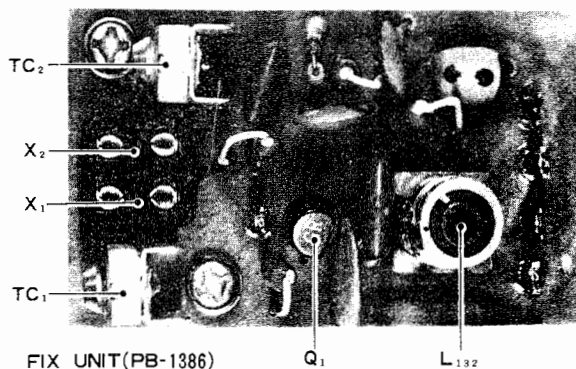

Fig. 21

12. Fix (Crystal Controlled Channel) Oscillator

Insert a crystal into the socket of the FIX unit, PB1386. Set the VFO SELECT switch to either FIX 1 or FIX 2 position for which crystal is installed. Set the CLARIFIER to the OFF position.

Connect the RF probe of a VTVM to pin 7 of the VFO EXT socket on the rear panel. Adjust L132 for a 0.1 volt VTVM reading. Connect the frequency counter to pin 7 where the VTVM was connected.

The crystal holders accept standard HC25 U type crystals. All crystal frequencies must fall between 5,000 KHz and 5,500 KHz. The correct crystal frequency for any desired operating frequency may be determined by the following formula.

$$f_x = f_1 - \text{operating frequency}$$

where f_x = Crystal frequency

f_1 = Constant taken from following table:

BAND	LSB	USB	CW AM
3.5	9001.5	8998.5	8999.3
7.0	12501.5	12498.5	12499.3
14	19501.5	19498.5	19499.3
21	26501.5	26498.5	26499.3
28A	33501.5	33498.5	33499.3
28B	34001.5	33998.5	33999.3
28C	34501.5	34498.5	34499.3
28D	35001.5	34998.5	34999.3

Table 3

For example;

To find the proper crystal frequency for operation at 7099 KHz, LSB on the 40 meter band, calculate as follows:

From the Table 3, find the constant f_1 for 40 meter LSB. This constant is 12501.5 KHz, therefore.

$$f_x = 12501.5 - 7099 = 5402.5 \text{ KHz}$$

13. Receiver IF Transformer, T101 through T109 on PB1382.

Set the BAND switch to 14 MHz, the VFO dial to 0 KHz and the CALIBRATOR to the ON position. Tune the transceiver to the marker signal at 14,000 KHz. Peak T101 through T109 for a maximum S-meter indication. When the marker signal is too strong, detune the PRESELECTOR until the maximum S-meter indication is less than S-5 in order to avoid the AGC effect.

14. Transmitter IF Circuit T110 and TC5 on PB-1384; T106 on PB-1382.

Connect the output of an audio signal generator to pin 0 of the MIC Jack and set its output to 20 mV at 1,000 Hz. Set the MODE switch to USB or LSB, and the VOX GAIN to the MOX position. Advance the MIC GAIN until the IC increases to 150 mA. Peak T110 and TC5 for a maximum IC reading. Peak T106 on PB-1382 for a maximum IC reading. Do not exceed an IC limit of 150 mA and the time limit of 10 seconds continuous transmit during this alignment otherwise damage may result to the final tubes.

15. Trap Coils L120, L121

Set the BAND switch to the 7.0 MHz band, the MODE to USB and the PRESELECTOR to the fully clockwise position in the receive mode. Connect the output of a signal generator set to exactly 9 MHz with an output of 60 db. Adjust L120 and L121 for minimum audio output.

16. Transmitter Mixer/Driver and Receiver Front End Stages

Assuming that the signal generating stages of the transceiver are functioning properly, use the internally generated signal of the transceiver to align the transmitter mixer and driver stages and the Standard Signal Generator to align the receiver front end. The internal marker signal can be used when a SSG is not available.

Prior to starting the alignment, set TC2 on the band switch (refer to the bottom view) to its 2/3 capacitance position. Connect a 50 ohm dummy load to the antenna jack on rear panel.

(1) 28 MHz band; L105, L110, L115

Set the BAND switch to the 28 MHz band, the sub band switch to 29.0, the VFO dial to 0 KHz, the PRESELECTOR to the 12 o'clock position and the MODE switch to the TUNE position.

Tune the transceiver to the 29.0 MHz marker signal. Detune the VFO until the S-meter reading falls to S-3 or less in order to avoid saturation by the AGC action of the receiver during the receiver front end alignment. Peak L105 and L110 for a maximum S-meter reading.

Set the VOX GAIN control to the MOX position. Advance the CARRIER control until the IC indicates 150 mA and peak L115 for a maximum power output.

CAUTION

EXCEEDING THE TIME LIMIT OF 10 SECONDS WITH CONTINUOUS FULL POWER OUTPUT DURING TRANSMITTER TUNING, MAY RESULT IN DAMAGE TO THE FINAL OUTPUT TUBES.

(2) 21 MHz; L104, L109, L114

Set the BAND switch to 21.0 MHz, the VFO dial to 0 KHz and the PRESELECTOR to the "2" position.

Peak L104 and L109 for a maximum S-meter reading and L114 for maximum power output using the same procedures described in step (1) above.

When the PRESELECTOR setting does not coincide between receive and transmit, carefully find a compromise point by realigning L109 and L114.

(3) 14 MHz; L103, L108, L113

Align L103, L108 and L113 using the same procedures as the 21 MHz band with the BAND switch set to the 21.0 MHz position.

(4) 7 MHz; L102, L107, L112

Align L102, L107 and L112 using the same procedures as the 21 MHz band with the BAND switch to the 7.0 MHz position.

(5) 3.5 MHz L101, L106, L111

Align L101, L106 and L111 using the same procedures as the 21 MHz band with the setting of BAND switch to 3.5 MHz, the VFO dial to 750 KHz and the PRESELECTOR to the 12 o'clock position.

VOLTAGE CHART

TUBES

T : Transmit mode LSB with no modulation R : Receive mode LSB VTVM AC 8kΩ/V, DC 20kΩ/V

	P		1		2		3		4		5		6		7		8		9		10		11		12			
	T	R	T	R	T	R	T	R	T	R	T	R	T	R	T	R	T	R	T	R	T	R	T	R	T	R	T	R
V1 12BY7A	-	-	4.4	0	0	-40	0	0	0	0	0	0	AC 12.0	AC 12.0	NC	NC	300	320	220	250	0	0	-	-	-	-	-	-
V2 6JS6C	620	660	0	0	0.04	0	155	165	0	0	-55	-80	0	0	0	0	0	0	0	0	-55	-80	0	0	155	165	AC 6.0	AC 6.0
V3 6JS6C	620	660	AC 6.0	AC 6.0	0.04	0	155	165	0	0	-55	-80	0	0	0	0	0	0	0	0	-55	-80	0	0	155	165	AC 12.0	AC 12.0

RF Unit

T : Transmit mode LSB with no modulation R : Receive mode LSB

	E		C		B			S		D		G (G1)		(G2)	
	T	R	T	R	T	R		T	R	T	R	T	R	T	R
Q2 2SC784R	0.35	0.375	2.8	2.9	0.8	0.9	Q1 2SK19GR	1.45	1.4	10.0	10.5	0	0	-	-
Q3 2SC784R	2.2	2.3	10.0	10.5	2.8	2.9	Q4 3SK40M	9.8	3.5	12.0	12.0	2.8	2.8	2.8	2.8
Q6 2SC373	0.85	0.8	6.2	7.2	0.9	1.35	Q5 3SK40M	10.0	2.45	11.0	11.5	0.6	0.6	2.0	1.95
Q7 2SC784R	0.85	11	11.5	12.0	1.2	6.2									

IF Unit

T : Transmit mode LSB with no modulation R : Receive mode LSB

Q7.....NB SW ON

	E		C		B			E		C		B	
	T	R	T	R	T	R		T	R	T	R	T	R
Q1 2SC372Y	9.0	0.75	11.5	12	3.0	1.25	Q9 2SC373	9.75	1.15	11.5	12.5	2.6	1.9
Q2 2SC784R	1.6	1.6	7.3	7.3	2.4	2.4	Q10 2SC373	9.6	1.35	11.5	12.0	3.0	1.85
Q3 2SC372Y	0.85	0.9	11.5	12.0	1.4	1.45	Q12 2SC372Y	0	0	9	9	0	0
Q4 2SC784R	0.8	0.85	11.5	12.0	1.4	1.45	Q13 2SC372Y	0	0	8.2	8.2	0	0
Q7 2SC372Y	0	0	11.0	11.5	0.46	0.46	Q14 2SC372Y	1.1	11	11.5	12	1.55	5
Q8 2SC373	2.1	11.0	11.0	12.0	2.5	5.2							

	S		D		G	
	T	R	T	R	T	R
Q5 2SK19GR	1.25	1.25	4.2	4.2	0	0
Q6 2SK19GR	1.3	1.3	1.85	1.85	0	0
Q11 2SK19GR	1.9	1.9	11	12	0	0

AF Unit

T : Transmit mode LSB with no modulation R : Receive mode LSB

Q3.....CALIB SW ON

	1		2		3		4		5		6		7		8		9	
	T	R	T	R	T	R	T	R	T	R	T	R	T	R	T	R	T	R
Q3(100kHz) MFC-6020	0	0	0.65	0.65	0	0	0	0	0	0	0	0	-	-	-	-	-	-
Q3(25 kHz) MFC-6020	0	0	1.0	1.0	2.5	2.5	2.6	2.6	2.5	2.5	5.0	5.0	-	-	-	-	-	-
Q4 MFC-6034A	0	0	12.0	13.0	6.1	6.1	6.0	6.0	7.4	7.4	4.0	4.1	-	-	-	-	-	-
Q6 LD-3141	0.65	0.7	0.58	0.65	0.04	0.04	0	0	1.2	1.25	4.6	5.0	4.6	5.0	12.0	12.5	11.5	12.0
Q11 AN-214	5.7	6.0	0	0	7.1	7.4	10.0	10.5	5.6	6.0	0	0	5.2	5.5	11	11.5	12.0	13.0

	E		C		B			E		C		B	
	T	R	T	R	T	R		T	R	T	R	T	R
Q1 2SC735Y	0.5	0.5	9.0	9.0	-0.35	-0.35	Q7 2SC372Y	0.9	0.95	9.8	9.8	1.4	1.5
Q2 2SC735Y	0	0	-0.15	-0.15	-0.15	-0.15	Q9 2SC373	0	0	0	13.0	0.52	0.55
Q5 2SC373	8.6	7.8	8.8	8.95	2.2	1.5	Q10 2SC372Y	0	0.55	0	0.8	0	0.95
Q2 2SC735Y	0.3	0.3	9.0	9.0	0.25	0.25							

	S		D		G	
	T	R	T	R	T	R
Q8 2SK19GR	0.38	0.39	0.52	0.55	0	0

MIC AMP Unit

T : Transmit mode LSB with no modulation R : Receive mode LSB

	1		2		3		4		5		6		7		8		9	
	T	R	T	R	T	R	T	R	T	R	T	R	T	R	T	R	T	R
Q2 LD 3141	0.9	0.95	1.2	1.2	0.7	0.7	0.65	0.65	1.8	1.85	5.0	5.4	5.0	5.5	11.5	12.0	11.0	12.0

	S		D		G	
	T	R	T	R	T	R
Q1 2SK19GR	2.4	2.4	7.3	8	0	0

VFO Unit

T,R : Transmit and Receive

	E		C		B			E		C		B	
	T	R	T	R	T	R		T	R	T	R	T	R
Q1 2SC372Y	1.5	1.5	3.3	3.3	1.85	1.85	Q2 2SC372Y	0.75	0.75	5.5	5.5	1.25	1.25

CARRIER OSC Unit

T : Transmit mode LSB R : Receive mode LSB with no modulation

	E		C		B			E		C		B	
	T	R	T	R	T	R		T	R	T	R	T	R
Q1 2SC372Y	0.45	0.45	6.0	6.0	0.9	0.9	Q1 2SC372Y	7.2	7.4	12.5	13.5	1.0	1.05
Q2 2SC372Y	0.55	0.55	6.0	6.0	0.95	0.95	Q5 2SC372Y	1.35	1.45	8.3	9.0	1.8	2.0
Q3 2SC372Y	7.5	7.6	6.0	6.0	1.6	1.75	Q8 2SC372Y	0	0	4.3	4.5	1.2	1.3

	S		D		G			S		D		G	
	T	R	T	R	T	R		T	R	T	R	T	R
Q6 2SK19Y	1.15	11.5	12.0	13.5	0	9.1	Q7 2SK19Y	1.0	1.0	1.15	1.1	0	1.9

PREMIX Unit

T : Transmit mode LSB R : Receive mode LSB with no modulation

	1		2		3		4		5		6		7		8		9		10	
	T	R	T	R	T	R	T	R	T	R	T	R	T	R	T	R	T	R	T	R
Q1 MC1496G	3.3	3.5	2.7	2.9	2.7	2.9	3.3	3.5	1.075	1.1	10.5	11	6.2	6.5	6.4	6.6	11.5	12	0	0

	E		C		B	
	T	R	T	R	T	R
Q2 2SC372Y	0.6	0.6	6.0	6.0	0.95	0.95

FIX Unit

	S		D		G	
	T	R	T	R	T	R
Q1 2SK19GR	0.35	0.35	4.2	4.2	0	0

CONNECTORS

T : Transmit mode LSB R : Receive mode LSB with no modulation

	1		2		3		4		5		6		7		8		9		10		11		12	
	T	R	T	R	T	R	T	R	T	R	T	R	T	R	T	R	T	R	T	R	T	R	T	R
J4 MIC	0	0	0	0	0	12.5	NC	NC	-	-	-	-	-	-	-	-	-	-	-	-	-	-	-	-
J10 EXT VFO	0	0	NC	NC	12.0	12.5	0	0	0	0	NC	NC	0	0	-	-	-	-	-	-	-	-	-	-
J12 ACC	AC 12.0	AC 12.0	AC 12.0	AC 12.0	155	160	300	320	620	660	-155	-160	0	0	0	0	0	0	0	0	NC	NC	-	-

- J11 FAN ①~③ AC 100V
 J13 POWER ②,③~④ AC 100V SW ON
 J4 PTT R, 12.5V T, 0
 J8 KEY CW R, -80V T, -80V -55V (KEY DOWN)

RESISTANCE CHART

		PIN	1	2	3	4	5	6	7	7	8	9	10	11	12	14	15
		P.S															
RF UNIT	1		40	0	20	0	2K	-	0	0	90	120	0	160	-	-	-
			∞	0	2K	∞	180K	-	4K	3.5K	∞	5K	0	4.7K	-	-	-
IF UNIT	2		240	240	-	2K	20	0	700	0	-	-	90	-	-	-	-
			∞	∞	-	28K	1.5K	2.8K	2.8K	0	-	-	∞	-	-	-	-
	3		20	5.5K	1.2K	0	-	-	-	0	0	2K	1.5K	2K	-	-	-
			15K	∞	18K	0	-	-	-	0	0	2K	2K	2K	-	-	-
	4		0	0	90	40	2K	110	∞	0	20	0	∞	25K	0	∞	500
			1.5K	0	∞	40	2K	2.2K	∞	0	250	1.6K	∞	25K	0	∞	600
AF UNIT	5		0	0	15	3K	20	-	80	60	0	0	60K	20	40K	0	-
			0	∞	15	3K	400	-	500	600K	∞	∞	200K	150K	160K	130	-
	6		-	2.2K	0	0	35K	1.5K	-	20	90	90	-	-	-	-	-
			-	6K	0	∞	100K	3.5K	-	300	200	7K	-	-	-	-	-
	7		-	-	20	20	110	-	0	0	0	4	-	-	-	-	-
			-	-	30	30	200K	-	∞	0	0	50K	-	-	-	-	-
MIC UNIT	8		0	0	0	2.5K	20	6K	0	10K	0	∞	-	-	-	-	-
			∞	∞	0	15K	12K	∞	0	∞	0	∞	-	-	-	-	-
CARRIER UNIT	9		300	∞	20	110	0	400K	90	0	700	∞	0	0	20	2.5K	450
			350	∞	2K	5K	0	400K	1.5K	600	2K	∞	0	2K	2K	∞	1.8K
12BY7A	V ₁		180	75K	0	0	0	-	65	7K	0	-	-	-	-	-	-
6JS6C	V ₂		0	0	65	0	50K	0	0	0	50K	0	65	0.5	-	-	-
6JS6C	V ₃		0.5	0	65	0	50K	0	0	0	50K	0	65	1.0	-	-	-

VOX GAIN }
 AF GAIN } 0
 MIC GAIN }
 CARRIER }
 RF GAIN } 10

Measured with VTVM of 20kΩ/V.

Upper values are resistance between pins and ground with the printed boards installed.
 Lower values are resistance between pins and ground with the printed boards removed from the sockets.

MAIN-CHASSIS				SP	SPEAKER	
V	VACUUM TUBE			1	SA-70	4Ω-3W
1	12BY7A					
2, 3	6JS6C			M	METER	
				1	PF-45	0.5mA/0.5 A
VS	VACUUM TUBE SOCKET					
1	S9-241-04	9P			INDUCTOR	
2, 3	SB-2606	12P		1, 3, 5, 6	RF CHOKE(TV245)	250μH
				2, 4, 9, 10	RF CHOKE	250μH
J	JACK SOCKET			7, 8	RF CHOKE	1 mH
1	J50-239			127	RF CHOKE(PLATE)	500μH
2, 3, 4, 5	RCA CN-7017			139	RF CHOKE	300μH
6	FM-144J					
7	SG-7814	3P		PS	PIN CONNECTOR SOCKET	
8	SG-7615-1	2P		1, 2, 3	128-12-10-181 S	
9	P-2240			4, 5, 9	128-15-10-181 S	
10	SB-0821	7P		6, 7, 8	128-10-10-181 S	
11	SA602B00	11P				
12	SI-6303-1	4P		D	DIODE	
13	450-AB12M	12P		1, 2, 3, 4, 5, 6, 7, 9, 10, 12	Si 1S1555	
				8, 11	Ge 1S1007	
RL	RELAY					
1	12V AE3171-42				FAN	
2	12V MX-2P			FAN	2SB-10A	
				FAN PLUG	SI-5908	
RLS	RELAY SOCKET					
1	AE3860			C	CAPACITOR	
2	PX08				DIPPED MICA	
				19, *33	500 WV 2PF	±0.5PF
S	SWITCH			24, 64	500 WV 5PF	±0.5PF
1	BAND-A ROTARY RS 8-16-5			23, 29, 41, 42, 53	500 WV 10PF	±10%
2	BAND-B ROTARY ESR-E245R25C			32, 81	500 WV 15PF	±10%
3	SEESAW WD2101			21, 22, 72	500 WV 20PF	±10%
4	SEESAW WD2301			31	500 WV 25PF	±10%
5	PUSH 5F-002DF1911			18, 20, 30, 48, 70, 71	500 WV 40PF	±10%
6	ROTARY ESR-E365R25B			73	500 WV 50PF	±10%
7	ROTARY ESR-E246R25C			47	500 WV 80PF	±10%
				16, 17, 34	500 WV 100PF	±10%
F	FUSE			28	500 WV 120PF	±10%
1	AC 5A(100~117V)			25, 26, 40, 43	500 WV 150PF	±10%
2	LAMP FUSE 16V-0.15A 08-1596			69	500 WV 170PF	±10%
				39, 45	500 WV 300PF	±10%
FS	FUSE HOLDER			11	500 WV 350PF	±10%
1	AC SN-1001			65	500 WV 400PF	±10%
2	B-1			62	500 WV 470PF	±10%
				63	500 WV 680PF	±10%
PL	LAMP			27	500 WV 1000PF	±10%
1, 2, 3	16V-0.15A	08-1596		51	500 WV 2000PF	±10%
					MOULDED MICA	
LS	LAMP SOCKET			55	1KWV 50PF	±10%
1, 2	001410A			74	1KWV 80PF	±10%
3	#001011			108	1KWV 100PF	±10%
				44	1KWV 200PF	±10%
VR	VARIABLE RESISTOR			60	3KWV 1000PF	±10%
1	EVK-A2A-R20-314	1kΩC/5kΩA			CERAMIC DISC	
2	EVK-A2A-R20-339	5kΩB/5kΩA		76, 77, 78, 79, 93,	50 WV	0.01μF -80% -0%
3	EVH-B0G-S25-14	10kΩB		94, 95, 97, 109		
4	EVH-B0A-R25-B54	50kΩB		3, 4, 5, 10, 14, 15, 66, 67, 68, 50 WV	0.047μF	-80% -20%
5	VM11-5M1222	50kΩB		80, 82, 83, 88, 89, 90, 91, 92, 96, 98		
6	V10K8-1-2	50kΩB		50	500 WV	0.0047μF -100% -0%
				35, 36, 37, 38, 49, 52	500 WV	0.01μF -100% -0%
VC	VARIABLE CAPACITOR			54, 56, 57, 58		
1	PRESELECTOR B535			59	1.4 KWV	0.0047μF -100% -0%
2	PLATE RT-18B-300VC	300PF		1, 2	1.4 KWV	0.01μF -100% -0%
3	LOAD B-1240DS			61	C104-100	3 KWV 100PF ±10%
					PLASTIC FILM	
TC	TRIMMER CAPACITOR			84	50 WV	0.047μF ±20%
1	AIR TSN-150C	10PF			ELECTROLYTIC	
2	CERAMIC ECV1ZW10P32	10PF		9	150 WV	1μF
				107	16 WV	10μF

105	16 WV	33 μ F			19	$\frac{1}{4}$ W	22 K Ω	$\pm 10\%$
6, 7	500 V	100 μ F			16	$\frac{1}{4}$ W	82 K Ω	$\pm 10\%$
106	25 WV	1000 μ F			1, 5, 10, 12, 15, 18	$\frac{1}{4}$ W	100 K Ω	$\pm 10\%$
CERAMIC FEED THRU					20, 28			
75	500 V	1000 PF	$\pm 100\%$ 0%		11, 13	$\frac{1}{4}$ W	220 K Ω	$\pm 10\%$
R RESISTOR				C CAPACITOR				
CARBON COMPOSITION				DIPPED MICA				
4, 44	$\frac{1}{2}$ W	10 Ω	$\pm 10\%$	2	50 WV	8 PF	$\pm 10\%$	
40	$\frac{1}{2}$ W	33 Ω	$\pm 10\%$	18	50 WV	10 PF	$\pm 10\%$	
41	$\frac{1}{2}$ W	39 Ω	$\pm 10\%$	8, 12	50 WV	30 PF	$\pm 10\%$	
32	$\frac{1}{2}$ W	56 Ω	$\pm 10\%$	1, 7, 10, 17	50 WV	100 PF	$\pm 10\%$	
42	$\frac{1}{2}$ W	82 Ω	$\pm 10\%$	CERAMIC DISC				
3, 14, 33, 34, 43	$\frac{1}{2}$ W	100 Ω	$\pm 10\%$	6, 9, 15, 16, 19, 20	50 WV	0.01 μ F	$\pm 80\%$ $\pm 20\%$	
19	$\frac{1}{2}$ W	180 Ω	$\pm 10\%$	3, 4, 5, 11, 13, 14, 21	50 WV	0.047 μ F	$\pm 80\%$ $\pm 20\%$	
35	$\frac{1}{2}$ W	220 Ω	$\pm 10\%$					
31	$\frac{1}{2}$ W	470 Ω	$\pm 10\%$					
7, 15, 24, 45, 55	$\frac{1}{2}$ W	1 K Ω	$\pm 10\%$	IF UNIT				
22, 30, 36	$\frac{1}{2}$ W	2.2 K Ω	$\pm 10\%$	P. C. B. PB-1382(A~Z)				
46, 47	$\frac{1}{2}$ W	4.7 K Ω	$\pm 10\%$	PP PIN CONNECTOR				
49	$\frac{1}{2}$ W	6.8 K Ω	$\pm 10\%$	1, 2	129-12-10-181 S			
6, 23, 48	$\frac{1}{2}$ W	10 K Ω	$\pm 10\%$	3	129-15-10-181 S			
11, 38, 39, 50, 51	$\frac{1}{2}$ W	15 K Ω	$\pm 10\%$	VR VARIABLE RESISTOR				
8, 10	$\frac{1}{2}$ W	22 K Ω	$\pm 10\%$	2, 3	V10K 8-4-2	500 Ω B		
9, 37	$\frac{1}{2}$ W	27 K Ω	$\pm 10\%$	1	V10K 8-1-2	10K Ω B		
12	$\frac{1}{2}$ W	33 K Ω	$\pm 10\%$					
16	$\frac{1}{2}$ W	47 K Ω	$\pm 10\%$					
1, 2	$\frac{1}{2}$ W	470 K Ω	$\pm 10\%$	T IF TRANSFORMER				
25	$\frac{1}{2}$ W	1 M Ω	$\pm 10\%$	101, 102, 103, 105, 106	R12-4073			
METALIC FILM				104, 107, 108, 109	R12-4074			
20	3 W	5.1 K Ω	$\pm 10\%$					
21	5 W	18 K Ω	$\pm 10\%$	L INDUCTOR				
WIRE WOUND				20	RF CHOKE	10 μ H		
METER SHUNT				1, 2, 3, 6, 7, 8, 9	RF CHOKE	250 μ H		
				9, 10, 11, 12, 13, 14, 15, 16, 17, 18				
				5, 19	RF CHOKE	1 mH		
T TRANSFORMER								
12	AF CHOKE	20mH	0.5A					
POWER TRANSFORMER								
				Q TRANSISTOR				
				1, 3, 7, 12, 13, 14	2SC372 Y			
				8, 9, 10	2SC373			
				2, 4	2SC784 R			
				5, 6, 11	2SK19GR			
				D DIODE				
				6, 7, 8, 9, 10	Ge	1S1007		
				11, 13, 14, 15, 17, 18, 19, 20, 21				
				1, 2, 3, 4, 5, 12, 16	Si	1S1555		
				22, 23	Zener	WZ090		
				XF CRYSTAL FILTER				
				1	XF-92A SSB			
				2	XF-90B AM(OPTION)			
				3	XF-90C CW(OPTION)			
				R RESISTOR				
				CARBON FILM				
				69	$\frac{1}{4}$ W	68 Ω	$\pm 10\%$	
				4, 12, 17, 28, 30, 32, 42	$\frac{1}{4}$ W	100 Ω	$\pm 10\%$	
				47, 51, 54, 63, 68, 71				
30	$\frac{1}{4}$ W	47 Ω	$\pm 10\%$	27, 41, 46, 50, 59	$\frac{1}{4}$ W	330 Ω	$\pm 10\%$	
27	$\frac{1}{4}$ W	56 Ω	$\pm 10\%$	8, 53, 66, 67, 77	$\frac{1}{4}$ W	470 Ω	$\pm 10\%$	
29, 31, 32	$\frac{1}{4}$ W	100 Ω	$\pm 10\%$	58	$\frac{1}{4}$ W	680 Ω	$\pm 10\%$	
3, 8, 17, 23	$\frac{1}{4}$ W	220 Ω	$\pm 10\%$	3, 7, 13, 16, 62, 73, 76	$\frac{1}{4}$ W	1 K Ω	$\pm 10\%$	
7, 22, 24	$\frac{1}{4}$ W	330 Ω	$\pm 10\%$	23	$\frac{1}{4}$ W	1.5 K Ω	$\pm 10\%$	
4	$\frac{1}{4}$ W	560 Ω	$\pm 10\%$	9, 43, 74	$\frac{1}{4}$ W	2.2 K Ω	$\pm 10\%$	
9	$\frac{1}{4}$ W	1 K Ω	$\pm 10\%$	10, 14, 24	$\frac{1}{4}$ W	3.3 K Ω	$\pm 10\%$	
21	$\frac{1}{4}$ W	1.8 K Ω	$\pm 10\%$	2, 6, 20, 35, 36, 45, 48, 61	$\frac{1}{4}$ W	4.7 K Ω	$\pm 10\%$	
2, 14	$\frac{1}{4}$ W	2.2 K Ω	$\pm 10\%$	26	$\frac{1}{4}$ W	8.2 K Ω	$\pm 10\%$	
25	$\frac{1}{4}$ W	3.3 K Ω	$\pm 10\%$	5, 21, 29, 31, 33, 38, 64, 72	$\frac{1}{4}$ W	10 K Ω	$\pm 10\%$	
6, 26	$\frac{1}{4}$ W	10 K Ω	$\pm 10\%$	1, 11, 15, 49, 56, 65, 70	$\frac{1}{4}$ W	22 K Ω	$\pm 10\%$	

39, 44, 60	1/4 W	27KΩ	±10%	12	1/4 W	1.2KΩ	±10%
25, 34, 37	1/4 W	47KΩ	±10%	1	1/4 W	4.7KΩ	±10%
18, 19, 22, 52	1/4 W	100KΩ	±10%	5, 6, 11	1/4 W	10 KΩ	±10%
57	1/4 W	470KΩ	±10%	2	1/4 W	22 KΩ	±10%
C CAPACITOR				C CAPACITOR			
DIPPED MICA				DIPPED MICA			
3, 61	50 WV	10 PF	±10%	14	50 WV	10 PF	±10%
8	50 WV	15 PF	±10%	3	50 WV	15 PF	±10%
24, 57, 89, 90, 91, 92, 94	50 WV	20 PF	±10%	2	50 WV	20 PF	±10%
95, 96				1	50 WV	40 PF	±10%
15, 43, 81, 93	50 WV	30 PF	±10%	13	50 WV	150 PF	±10%
4, 19	50 WV	50 PF	±10%	CERAMIC DISC			
18, 21, 22, 60	50 WV	100 PF	±10%	8, 9, 11, 12	50 WV	0.01 μF	-80% -20%
CERAMIC DISC				4, 5, 6, 7, 10	50 WV	0.047 μF	-80% -20%
1	50 WV	0.5 PF	±0.25 PF	CARRIER OSC UNIT			
11, 29, 30, 31, 34, 35, 38	50 WV	0.001 μF	+80% -0%	P. C. B. PB-1386(A~Z)			
39, 42, 47, 51, 62, 70, 72, 77				X CRYSTAL			
5, 9, 10, 13, 16, 17, 23, 25	50 WV	0.01 μF	+80% -0%	1	HC/18U	8998.5kHz	(SSB)
28, 44, 48, 58, 69, 75, 88				2	HC/18U	9001.5kHz	(SSB)
2, 6, 7, 12, 14, 27, 32	50 WV	0.047 μF	+80% -0%	3	HC/18U	8999.3kHz	(CW·AM)
33, 36, 37, 40, 41, 45, 46, 49, 50, 52				TC TRIMMER CAPACITOR			
53, 54, 55, 56, 59, 66, 67, 68, 71, 73				1, 2, 3	ECV-1ZW	20P40	20 PF
74, 78, 79, 80, 82, 84, 85, 86, 87, 98, 101				4, 5	ECV-1ZW	50P40	50 PF
PLASTIC FILM				6	ECV-1ZW	40P32	40 PF
20	50 WV	0.1 μF	±20%	L INDUCTOR			
63	50 WV	0.2 μF	±20%	1	RF CHOKE		10 μH
ELECTROLYTIC				2, 3, 4	RF CHOKE		250 μH
102	16 WV	1 μF		133, 134, 135	RF CHOKE		
26, 65, 76, 99, 100	16 WV	10 μF		136, 137	RF CHOKE		
SOLID ELECT				T IF TRANSFORMER			
64	25 WV	1 μF		110			R12-4074
97	25 WV	2.2 μF		VR VARIABLE RESISTOR			
PREMIX UNIT				1			
P. C. B. PB-1383(A~Z)				2			
X CRYSTAL				2			
1	HC/18U	21.5 MHz		D DIODE			
2	HC/18U	28.5 MHz		1, 2, 3, 4	Ge	1S1007	
3	HC/18U	29.5 MHz		Q TRANSISTOR			
4	HC/18U	35.5 MHz		1, 2, 3, 4, 5, 8		2SC372Y	
5	HC/18U	42.5 MHz		6, 7		2SK19Y	
6	HC/18U	43.0 MHz		PP PIN CONNECTOR			
7	HC/18U	43.5 MHz		1		128-15-10-181 P	
8	HC/18U	44.0 MHz		R RESISTOR			
TC TRIMMER CAPACITOR				CARBON FILM			
1, 2, 3, 4, 5, 6, 7, 8	ECV-1ZW	20P51	20PF	14, 19, 23, 26, 29	1/4 W	100 Ω	±10%
L INDUCTOR				12	1/4 W	180 Ω	±10%
1	RF CHOKE	250 μH		3, 6, 9	1/4 W	270 Ω	±10%
2	RF CHOKE	1 mH		13, 20, 30	1/4 W	470 Ω	±10%
140	OSC COIL			24	1/4 W	560 Ω	±10%
Q TRANSISTOR				15, 18	1/4 W	1 KΩ	±10%
1	IC	MC 1496 G		16, 28	1/4 W	1.5KΩ	±10%
2		2SC372Y		22, 25	1/4 W	2.2KΩ	±10%
VR VARIABLE RESISTOR				1, 4, 7, 10	1/4 W	4.7KΩ	±10%
1		SR19R001-47KΩB		2, 5, 8, 11	1/4 W	22 KΩ	±10%
R RESISTOR				17	1/4 W	33 KΩ	±10%
CARBON FILM				21	1/4 W	100 KΩ	±10%
13	1/4 W	56 Ω	±10%	27		THERMISTOR	SDT-250
14	1/4 W	100 Ω	±10%	C CAPACITOR			
3	1/4 W	330 Ω	±10%	DIPPED MICA			
4	1/4 W	470 Ω	±10%	9	50 WV	3 PF	±0.5PF
10	1/4 W	820 Ω	±10%				
7, 8, 9	1/4 W	1 KΩ	±10%				

3, 6, 18, 22	50 WV	30 PF	±10%	AF UNIT	
24	50 WV	50 PF	±10%	P. C. B.	PB-1385(A~Z)
2, 5, 8	50 WV	130 PF	±10%	S SWITCH	
19	50 WV	150 PF	±10%	1	SLIDE SS-F-22-08
12	50 WV	200 PF	±10%		
28	50 WV	250 PF	±10%	X CRYSTAL	
13, 29	50 WV	470 PF	±10%	1	HC/13U 100 kHz
7	CERAMIC DISC			PP PIN CONNECTOR	
1, 4, 11, 14, 16, 17, 20, 21	50 WV	0.001 μF	+80% -20%	1	129-15-10-181 P
23, 25, 26, 27, 30, 34	50 WV	0.01 μF	+80% -20%	2, 3	129-10-10-181 P
10, 31, 32, 33	50 WV	0.047 μF	+80% -20%		
15	PLASTIC FILM			VR VARIABLE RESISTOR	
35	ELECTROLYTIC			2, 5	V10K8-1-2 10 KΩB
	16 WV	47 μF		3	V18K3-2 10 KΩB
				1	V18K3-2 20 KΩB
				4	V18K3-2 2 MΩB
VFO UNIT				L INDUCTOR	
P. C. B.		PB-1199(A~Z)		1, 2	RF CHOKE S6 392 3.9 mH
Q TRANSISTOR				3	RF CHOKE 250 μH
1, 2	2SC372Y				
D DIODE				TC TRIMMER CAPACITOR	
1	VARACTOR 1S2236			1	ECV1ZW50P 40 50 PF
L INDUCTOR				Q TRANSISTOR	
3	RF CHOKE		250 μH	1, 2	2SC735 Y
2	RF CHOKE		1 mH	3	IC MFC-6020
130	OSC COIL			4	IC MFC-6034A
131	RF CHOKE			5, 9	2SC373
R RESISTOR				6	IC LD-3141
CARBON FILM				7, 10	2SC372 Y
9	1/4 W	22 Ω	±10%	8	2SK19GR
12, 13	1/4 W	100 Ω	±10%	11	IC AN-214
7	1/4 W	220 Ω	±10%	D DIODE	
4	1/4 W	2.2 KΩ	±10%	1, 2	ZENER WZ-090
1	1/4 W	3.3 KΩ	±10%	3, 4, 5, 6, 7, 8	Si 1S1555
6	1/4 W	8.2 KΩ	±10%	R RESISTOR	
10	1/4 W	10 KΩ	±10%	CARBON FILM	
3	1/4 W	18 KΩ	±10%	3, 6, 25	1/4 W 100 Ω ±10%
5, 11	1/4 W	22 KΩ	±10%	51	1/4 W 120 Ω ±10%
2	1/4 W	33 KΩ	±10%	8, 24	1/4 W 220 Ω ±10%
C CAPACITOR				7, 21, 29, 42, 45	1/4 W 470 Ω ±10%
DIPPED MICA				37	1/4 W 680 Ω ±10%
15	50 WV	8 PF	±10%	11, 26	1/4 W 1 KΩ ±10%
4, 6	50 WV	20 PF	±10%	10, 22, 28, 38, 41, 52	1/4 W 2.2 KΩ ±10%
7	50 WV	30 PF	±10%	44	1/4 W 3.3 KΩ ±10%
11	50 WV	50 PF	±10%	16, 17, 19, 31, 47	1/4 W 4.7 KΩ ±10%
8, 14	50 WV	250 PF	±10%	2, 4, 13, 14, 30, 39	1/4 W 10 KΩ ±10%
10	50 WV	470 PF	±10%	49	1/4 W 12 KΩ ±10%
2	50 WV	680 PF	±10%	12	1/4 W 18 KΩ ±10%
CERAMIC DISC				43, 50	1/4 W 22 KΩ ±10%
9, 12, 13, 16, 17, 18, 19	50 WV	0.01 μF	+80% -20%	20, 40	1/4 W 33 KΩ ±10%
21	50 WV	0.047 μF	+80% -20%	46	1/4 W 39 KΩ ±10%
CERAMIC TC				18, 23, 48	1/4 W 47 KΩ ±10%
1	N750	5 PF	±0.5PF	27	1/4 W 56 KΩ ±10%
5	N750	7 PF	±0.5PF	1, 5	1/4 W 100 KΩ ±10%
3	N750	20 PF	±10%	CARBON COMPOSITION	
VC VARIABLE CAPACITOR				9	1/2 W 4.7 Ω ±5%
1	B5240DS114			54	1/2 W 33 KΩ ±10%
TC TRIMMER CAPACITOR				33, 34	1/2 W 3.3 MΩ ±10%
1	AIR	TSN-170C	10 PF × 2	32	1/2 W 5.6 MΩ ±10%
2	AIR	TSN-150C	30 PF	35	1/2 W 1 MΩ ±10%
				METALIC FILM	
				15	2 W 6.8 KΩ ±10%
				THERMISTOR SDT-250	
				36	

C CAPACITOR				RECTIFIER UNIT			
DIPPED MICA				P. C. B.		PB-1387(A~Z)	
5, 7, 8, 10	50 WV	30 PF	±10%	D	DIODE		
6, 11	50 WV	40 PF	±10%	1, 2	Si	V06B	
1	50 WV	100 PF	±10%	3, 4	Si	1S1943	
2	50 WV	250 PF	±10%	5~12	Si	10D10	
4	500 WV	2000 PF	±10%	C CAPACITOR			
PLASTIC FILM				2	50 WV	0.047 μF	-80% -20%
13, 28, 39, 41, 51	50 WV	0.001 μF	±20%	1, 3, 5	500 WV	0.01 μF	-100% 0
31, 45, 47, 58, 59	50 WV	0.01 μF	±20%	4	1.4 KV	0.0047 μF	-100% 0
22, 23, 24	50 WV	0.22 μF	±20%	R RESISTOR			
35, 38, 44	50 WV	0.047 μF	±20%	CARBON FILM			
12, 27, 40, 52	50 WV	0.1 μF	±20%	1~8	¼ W	470 KΩ	±10%
CERMIC DISC				WIRE WOUND			
3, 9	50 WV	0.01 μF	+80% -20%	9	2 W	5.6 Ω	±10%
56, 57, 61	50 WV	0.047 μF	+80% -20%	MIC AMP UNIT			
ELECTROLYTIC				P. C. B.		PB-1388(A~Z)	
34, 36, 42, 62	16 WV	1 μF		PP	PIN CONNECTOR		
25, 32, 33, 37, 46, 50	16 WV	10 μF		1	128-10-10-181 P		
26	16 WV	22 μF		Q TRANSISTOR			
48	16 WV	33 μF		1	2SK19GR		
14, 21, 29, 30, 43, 53, 63	16 WV	100 μF		2	IC	LD3141	
49	16 WV	220 μF		R RESISTOR			
54, 55	16 WV	1000 μF		7	¼ W	100 Ω	±10%
15, 16	25 WV	1000 μF		5, 6	¼ W	1 KΩ	±10%
19	160 WV	22 μF		1, 3	¼ W	4.7 KΩ	±10%
17, 18, 20	250 WV	22 μF		4	¼ W	5.6 KΩ	±10%
FIX UNIT				2	¼ W	47 KΩ	±10%
P. C. B.		PB-1386(A~Z)		C CAPACITOR			
Q	TRANSISTOR			PLASTIC FILM			
1	2SK19GR			1	50 WV	0.01 μF	±20%
D DIODE				6	50 WV	0.047 μF	±20%
1	VARACTOR	1S2236		DIPPED MICA			
TC TRIMMER CAPACITOR				7	50 WV	200 PF	±10%
1, 2	ECV1ZW50P40	50 PF		ELECTROLYTIC			
L INDUCTOR				2, 4, 5, 8, 9, 10	16 WV	1 μF	
1	RF CHOKE	250 μH		11, 13	16 WV	22 μF	
2	FIX OUTPUT COIL			3, 12	16 WV	100 μF	
R RESISTOR				COIL UNIT			
CARBON FILM				P. C. B.		PB-1389(A~Z)	
2	¼ W	47 Ω	±10%	L	TUNING COIL		
1	¼ W	220 Ω	±10%	101	80 METER BAND	ANT COIL	
3, 5	¼ W	100 KΩ	±10%	102	40 METER BAND	ANT COIL	
C CAPACITOR				103	20 METER BAND	ANT COIL	
DIPPED MICA				104	15 METER BAND	ANT COIL	
5	50 WV	100 PF	±10%	105	10 METER BAND	ANT COIL	
3	50 WV	200 PF	±10%	106	80 METER BAND	GRID COIL	
CERAMIC DISC				107	40 METER BAND	GRID COIL	
1, 4	50 WV	0.01 μF	+80% -20%	108	20 METER BAND	GRID COIL	
2	50 WV	0.047 μF	+80% -20%	109	15 METER BAND	GRID COIL	
TRAP UNIT				110	10 METER BAND	GRID COIL	
P. C. B.		PB-1358(A~Z)		C CAPACITOR			
L	INDUCTOR			DIPPED MICA			
1	RF CHOKE	1.8 μH		27	50 WV	1000 PF	±10%
120	9 MHz	TRAP COIL		LED UNIT			
C CAPACITOR				P. C. B.		PB-1390(A~Z)	
DIPPED MICA				LED LIGHT EMI DIODE			
1	50 WV	350 PF	±10%	1, 2, 3	GD-4-204		
2, 3	50 WV	680 PF	±10%				

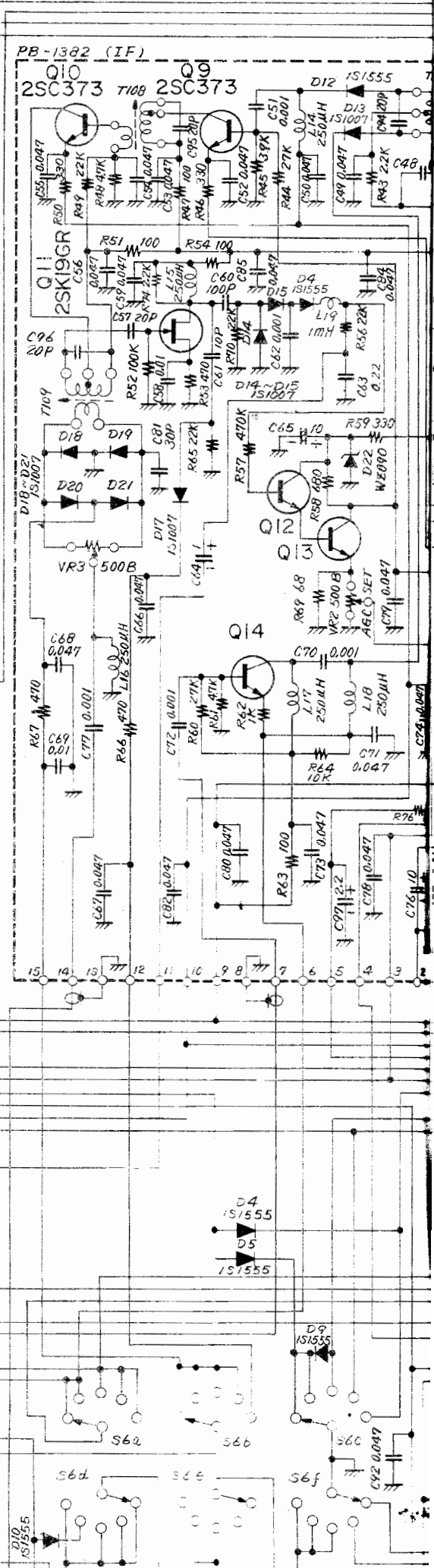
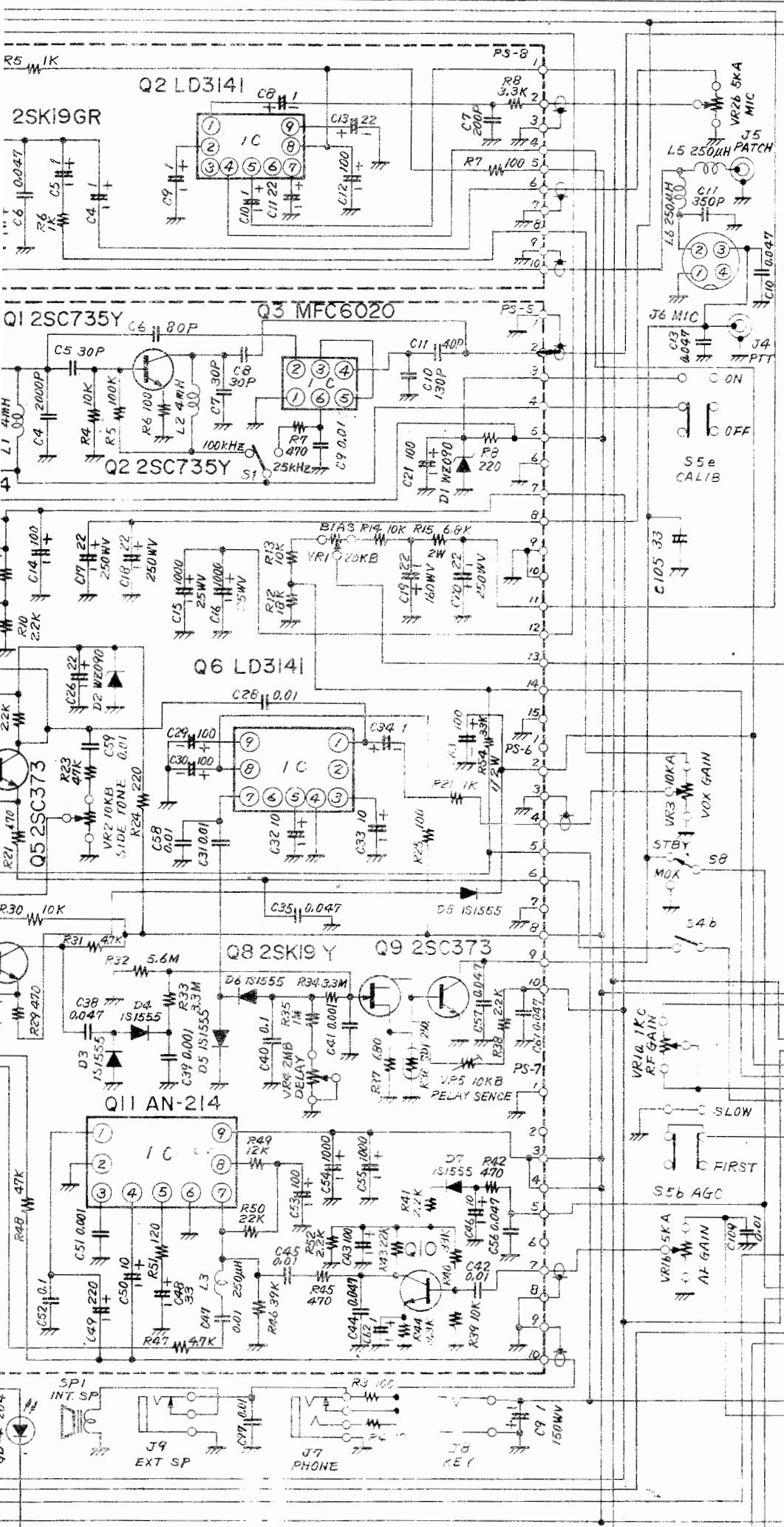

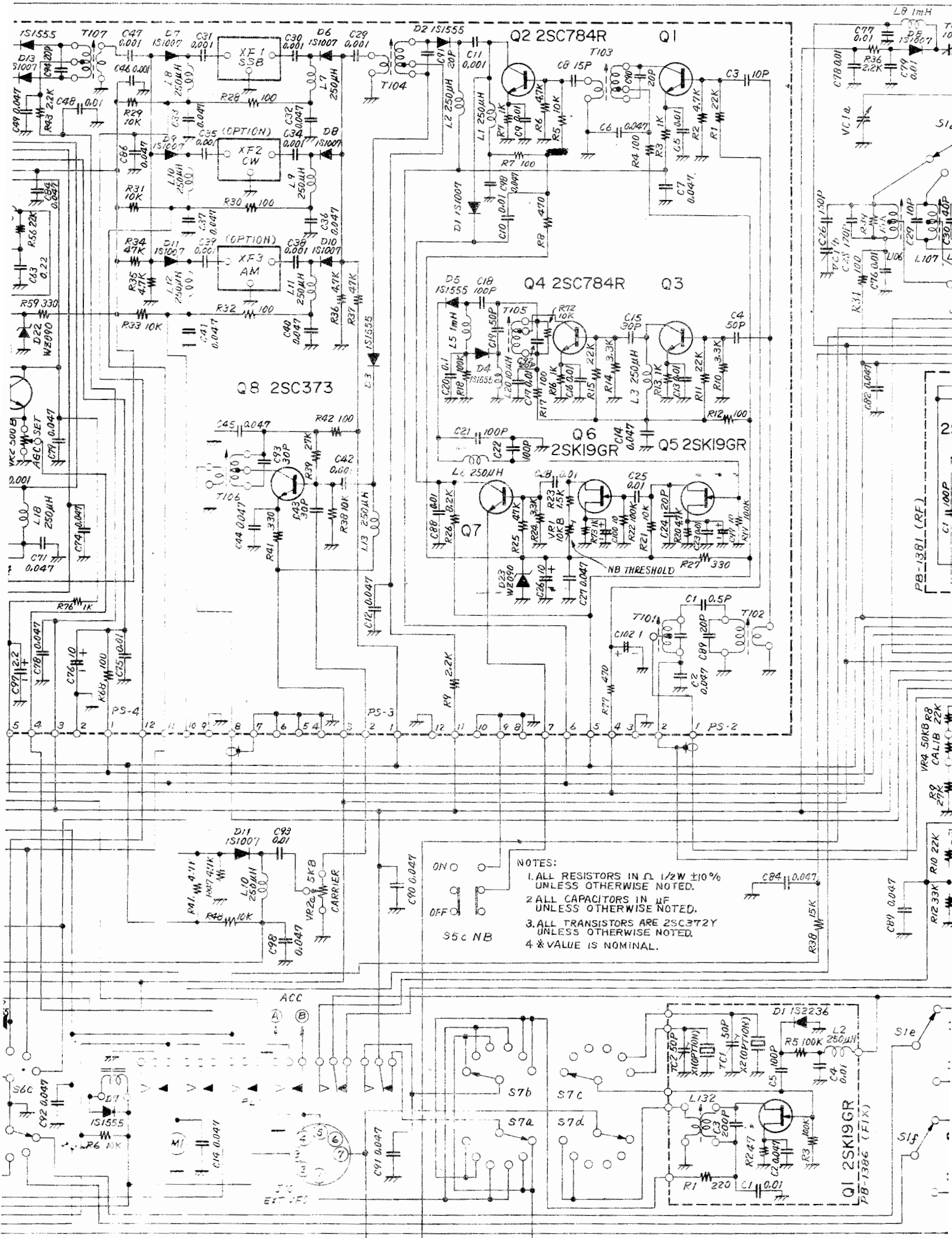

NOTES:
 1. ALL RESISTORS IN Ω 1/2W $\pm 10\%$ UNLESS OTHERWISE NOTED.
 2. ALL CAPACITORS IN μF UNLESS OTHERWISE NOTED.
 3. ALL TRANSISTORS ARE 2SC372Y UNLESS OTHERWISE NOTED.
 4. * VALUE IS NOMINAL.

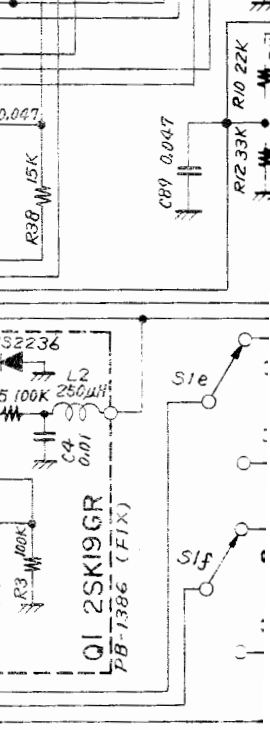
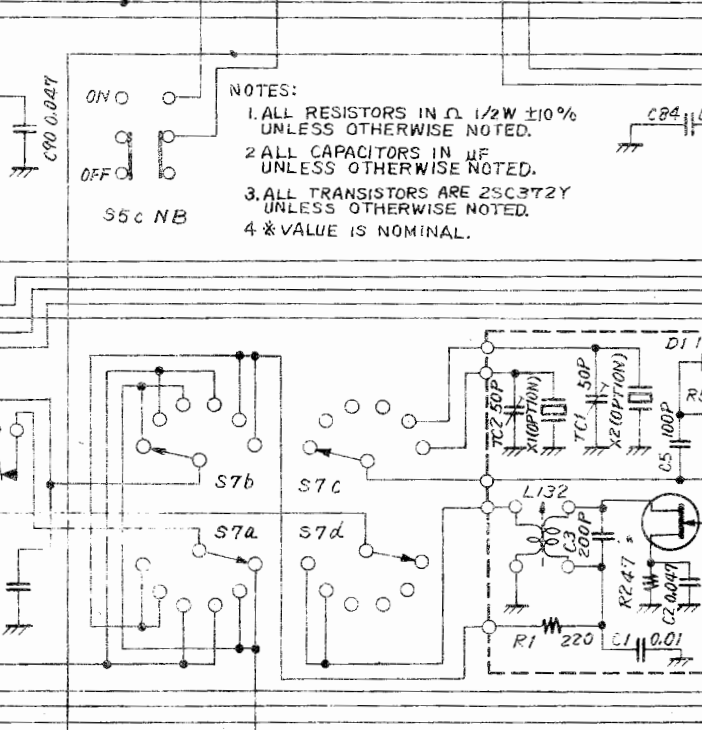
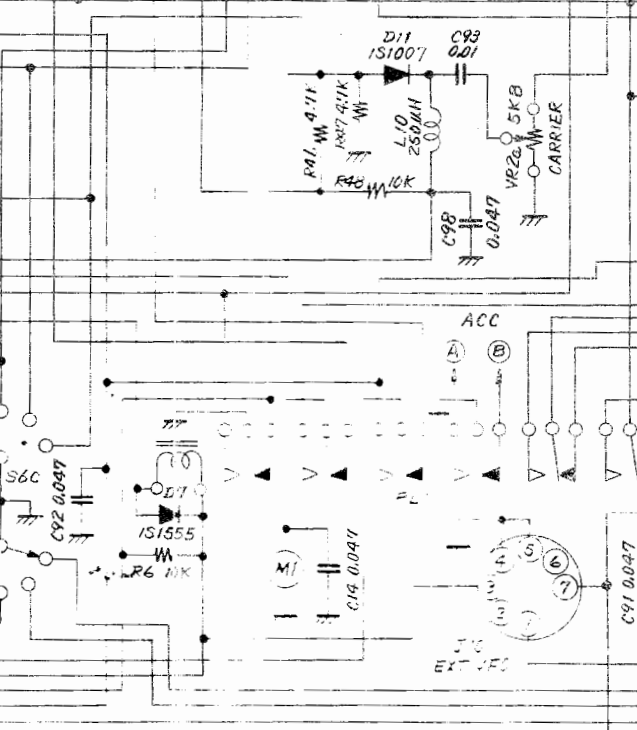
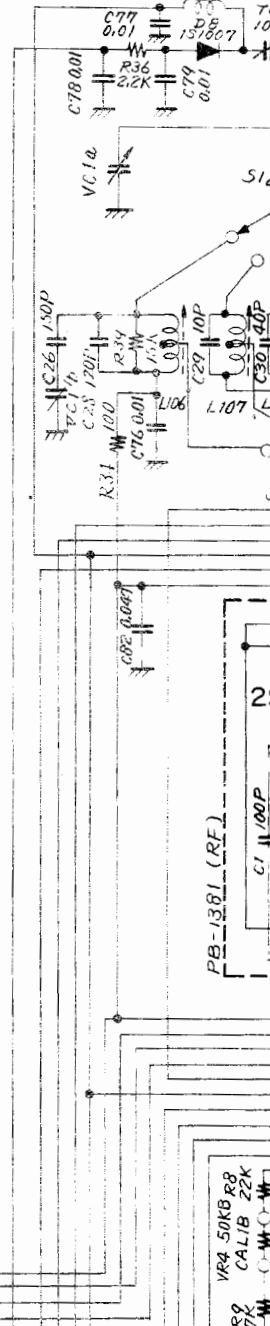
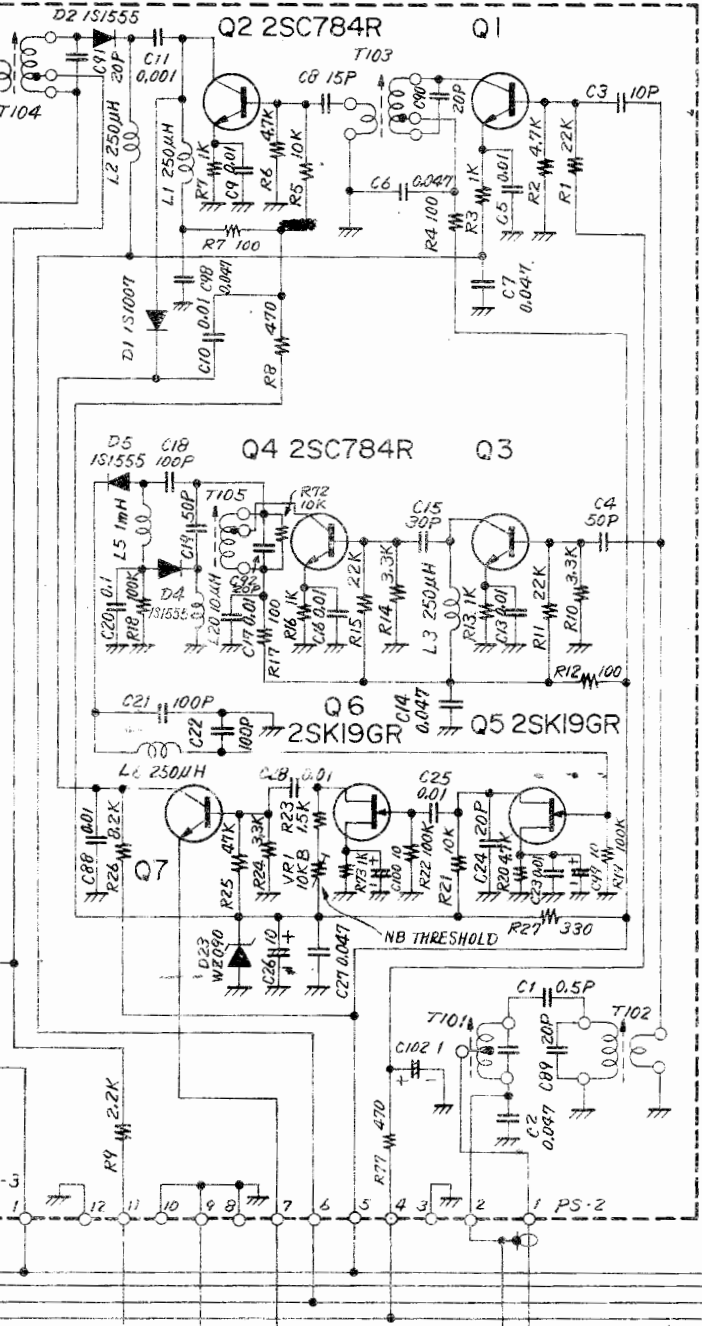
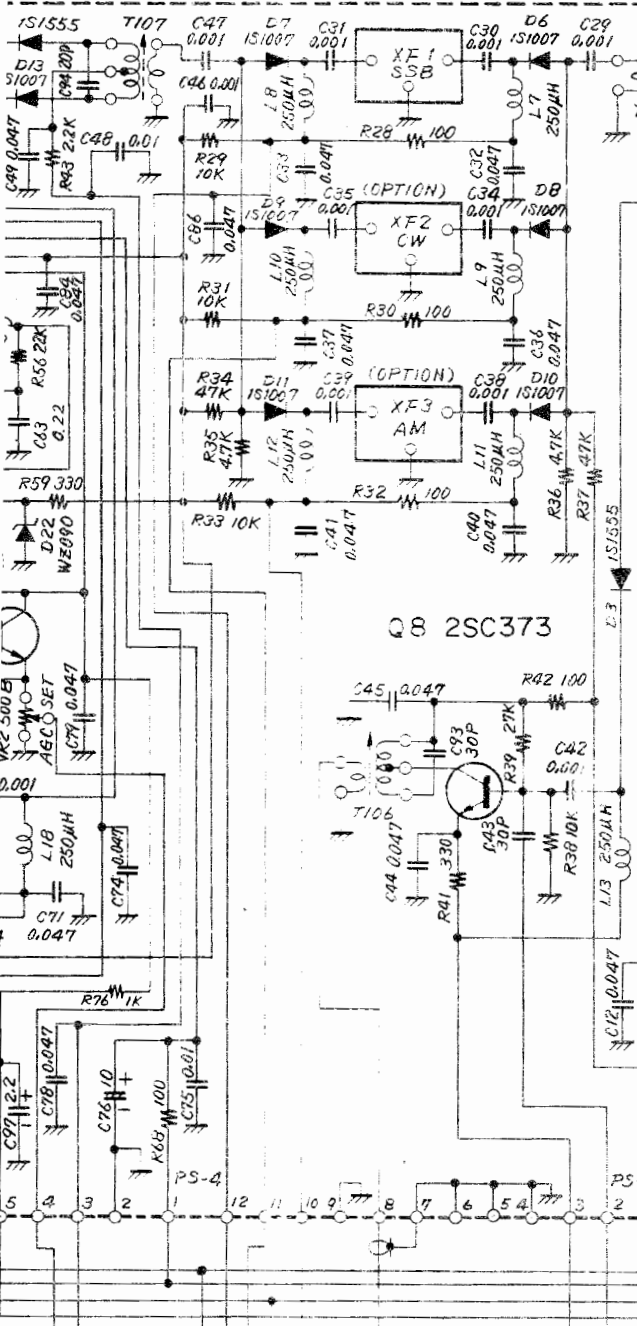

FT-201 CIRCUIT DIAGRAM

